

DMX9724XDS

MONITOR WITH RECEIVER INSTRUCTION MANUAL

JVCKENWOOD Corporation

- Updated information (the latest Instruction Manual, system updates, new functions, etc.) is available from <<https://www.kenwood.com/cs/ce/>>.
- The Instruction manual is subject to change for modification of specifications and so forth. Be sure to download the latest edition of the Instruction manual for reference.
<https://www.kenwood.com/cs/ce/im_edition/im409/>



Hi-Res Audio logo and Hi-Res Audio Wireless logo are used under license from Japan Audio Society.



SOFTWARE LICENSE AGREEMENT

Important Notice on Software

■ Software License on This Product

The software embedded in this product comprises a number of independent software components, each of which is copyrighted by JVCKENWOOD Corporation or by a third party. This product uses software components that are based on an End-User License Agreement (hereinafter called "EULA") stipulated by JVCKENWOOD Corporation and by third parties. The EULA dictates the availability of the source codes of free-software components as a prerequisite to distributing them in executable form under the terms of the GNU General Public License or the Lesser General Public License (hereinafter called "GPL/LGPL"). To get information about the software components that are subject to the terms of the GPL/LGPL, please visit the following Website:
Website URL <https://www2.jvckenwood.com/gpl/>

Queries concerning the contents of the source code or the like will not be accepted.

Please note that software components based on a EULA that is not subject to the terms of the GPL/LGPL or those that have been developed or created by JVCKENWOOD Corporation will be excluded from the scope of source code disclosure.

Because licenses to use software components distributed under the GPL/LGPL are offered to the customers for free of charge, no warranty is granted to the customers, whether explicitly or implicitly, to the extent of the applicable laws. Unless otherwise stipulated by the applicable laws or agreed upon in writing, the copyright holders or those who are entitled to modify and redistribute the software components are not held responsible for any and all damages resulting from their use or from inability to use them. For more information about the terms of use of the software components, required items of compliance and so on, please refer to the GPL/LGPL.

Customers wishing themselves to use a software component that is subject to the GPL/LGPL embedded in this product are encouraged to read the terms of the corresponding license before use. Because each individual license is prescribed by a third party other than JVCKENWOOD Corporation, the original (English) of the license is presented.

EULA

■ Software License Agreement

JVCKENWOOD Corporation (hereinafter called "Licensor") holds either the copyright to the embedded software or the right to sublicense it. This agreement establishes the conditions under which the customer uses this "Licensed Software."

The customer shall agree to the terms of this license agreement before proceeding to use Licensed Software.

This agreement is deemed to have taken effect when the customer (hereinafter called "User") has used a product implementation of Licensed Software.

The Licensed Software may contain software Licensor has been licensed to use by third parties directly or indirectly. Some third parties may have terms of use prescribed for their customers, apart from this Software License Agreement. This agreement does not apply to such software. Be sure to consult "Important Notice on Software" as presented separately.

Article 1 (General)

Licensor grants to User a non-exclusive, non-assignable right of use Licensed Software within the country where the User purchases the Product (hereinafter the "Country") (except for the exception provided for in Paragraph 1, Article 3).

Article 2 (Right of Use)

1. The rise of use granted under this agreement is the right to use Licensed Software in this product.
2. User may not duplicate, copy, modify, add to, translate or otherwise alter, or loan licensed Software and the associated literature in whole or in part.
3. Use of Licensed Software is limited to a private extent, and Licensed Software may not be distributed, licensed or sublicensed for any purposes whatsoever, including commercial use.
4. User shall use Licensed Software as per the instruction manual or instructions given in the help file and may not use or duplicate data in violations of the regulations of the Copyright Law or other governing laws by using Licensed Software in whole or in part.

Article 3 (Terms of License)

1. In assigning this product, User may not retain the original copy of the embedded Licensed Software (including associated literature, updates and upgrades) and any duplicates and associated literature with regard to the license to use Licensed Software. User may transfer Licensed Software only to the condition of binding the assignee to abide by the terms of this Software License Agreement.
2. User may not reverse-engineer, disassemble, decompile or otherwise analyze the source code of Licensed Software.

Article 4 (Rights to Licensed Software)

All rights to Licensed Software and the associated literature, including copyrights, shall reside with Licensor or the original right holder who has granted the Right of Use and right to sublicense to Licensor (hereinafter referred to as "Original Right Holder"), and User does not have any rights other than Right of Use granted hereunder with regard to Licensed Software and the associated literature.

Article 5 (Exemption Granted to Licensor)

1. Licensor and Original Right Holder do not assume any responsibility for damages caused to User or third parties resulting from the exercise by User of the license granted hereunder, unless otherwise provided by any law to the contrary.
2. Licensor does not warrant Licensed Software to be merchantable, compatible and fit for specific purposes.

Article 6 (Responsibility for Third Parties)

If disputes over the infringement of third parties' intellectual property rights, such as copyrights and patent rights, arise out of the use of Licensed Software by User, User shall resolve these disputes at User's own expenses while keep Licensor and Original Right Holder harmless.

SOFTWARE LICENSE AGREEMENT

Article 7 (Secrecy Obligation)

User shall keep confidential Licensed Software provided hereunder, information contained in the associated literature or the like and those provisions of this agreement not yet in public knowledge and may not disclose or leak these to third parties without prior written consent from Licensor.

Article 8 (Cancellation of the Agreement)

Licensor reserves the right to cancel this agreement forthwith and claim compensation from User for the damages caused by such cancellation when User:

- (1) Breaches any of the provisions of this agreement, or
- (2) Has received a petition for seizure, provisional seizure, provisional disposition or any other kind of compulsory execution.

Article 9 (Destruction of Licensed Software)

If this agreement is terminated under the provision of the foregoing paragraph, User shall destroy Licensed Software, along with all associated literature and its duplicates, within two (2) weeks from the date of termination.

Article 10 (Copyright Protection)

1. Copyrights and all other intellectual property rights relating to Licensed Software shall reside with Licensor and Original Right Holder and in no circumstances with User.
2. User shall abide by the laws relating to copyrights and intellectual property rights in using Licensed Software.

Article 11 (Export Control)

1. Licensed Software and the associated literature or the like may not be exported to places outside the Country (including transmission outside the Country over the Internet or the like).
2. User agrees that Licensed Software is subject to export controls imposed by the Country and the United States of America.
3. User agrees to comply with all the international and domestic laws that apply to this software (U.S. Export Administration Regulations and regulations established by the U.S., the Country and their governmental agencies regarding usage by end users and export destinations).

Article 12 (Miscellaneous)

1. Even if this agreement is invalidated in part by law, all other provisions shall remain in effect.
2. Licensor and User shall consult each other in good faith to resolve any matters not provided for in this agreement or questions arising from the interpretation of this agreement.
3. Licensor and User agree that this agreement is governed by the law of Japan and that all disputes involving claims and obligations that may arise out of this agreement will be settled by arbitration at the Tokyo District Court as the court of first instance.

Contents

Before Use 7

Precautions.....	7
How to read this manual	8

Basic Operations 9

Functions of the Buttons on the Front Panel	9
Touch screen operations	10
Turning on the Unit	10
Adjusting the volume	11
Turn off the screen.....	11
Put the unit in standby.....	12
Initial Settings.....	12
Display the HOME screen	15
Popup menu	15
Source selection screen description.....	16
Source control screen descriptions	17
List screen	18

Widget 20

Widget.....	20
Drive Widget Panel.....	21
Importing Image Files.....	21

APPS 22

Wireless Mirroring Operation	22
Apple CarPlay Operation.....	22
Android Auto™ Operation.....	24

USB 27

Connecting a USB device	27
USB Basic Operation.....	28
Search Operation	29

iPhone 31

Preparation.....	31
iPhone Basic Operation.....	32
Search Operation	33

Radio 35

Radio Basic Operation	35
Memory Operation.....	36
Selecting Operation	37
Traffic Information	37
Radio SETUP	38

Digital Radio 39

Digital Radio Basic Operation.....	39
Storing Service in Preset Memory.....	40
Selecting Operation	41
Traffic Information.....	42
Digital Radio SETUP.....	42

Bluetooth Control 44

Information for using Bluetooth® devices	44
Register the Bluetooth device.....	45
Bluetooth Setup	48
Playing the Bluetooth Audio Device.....	49
Using the Hands-Free Unit	51
Hands-Free Setup	56

Other External Components 57

View Camera.....	57
Use Dashboard Camera	60
External audio/video players (AV-IN).....	60
HDMI source	61

Vehicle Status 62

Pitch and Roll.....	62
---------------------	----

Setup 63

Monitor Screen Setup.....	63
Connection & AV Setup	64
Display & Button Setup.....	66
User Interface Setup.....	68
System Setup.....	69

Controlling Audio 71

Audio Setup..... 71
Speaker / X'over setup..... 72
Equalizer Control..... 73
Listening Position / DTA 74
Fader / Balance..... 76
Volume Offset..... 77
Sound Effect..... 77
Parametric Equalizer 78
Audio Setup memory..... 81

Remote control (optional) 82

Battery Installation..... 82
Functions of the Remote control Buttons..... 82

Connection/Installation 85

Before Installation 85
Installing the accessories..... 87
Installing the Big Screen model 89
Connecting the unit 93

Troubleshooting 98

Problems and Solutions..... 98
Error Messages 98

Appendix 100

Playable Media and Files 100
Specifications..... 102
About this Unit..... 105

Before Use

IMPORTANT

Please read this manual carefully to ensure proper use before using this product. It is especially important that you read and observe WARNINGS and CAUTIONS in this manual. Please keep the manual in a safe and accessible place for future reference.

Precautions

▲ WARNINGS

■ To prevent injury or fire, take the following precautions:

- To prevent a short circuit, never put or leave any metallic objects (such as coins or metallic tools) inside the unit.
- Do not watch or fix your eyes on the unit's display when you are driving for any extended period.
- If you experience problems during installation, consult your KENWOOD dealer.

■ Precautions on using this unit

- When you purchase optional accessories, check with your KENWOOD dealer to make sure that they work with your model and in your area.
- You can select a language to display menus, audio file tags, etc. See **System Setup (P.69)**.
- The Radio Data System feature won't work in areas where the service is not supported by any broadcasting station.

■ Protecting the monitor

- To protect the monitor from damage, do not operate the monitor using a ball point pen or similar tool with a sharp tip.

■ Cleaning the unit

- If the faceplate of this unit is stained, wipe it with a dry soft cloth such as a silicon cloth. If the faceplate is stained badly, wipe it with a cloth moistened with neutral cleaner, then wipe it again with a clean soft dry cloth.

NOTE

- Applying spray cleaner directly to the unit may damage its mechanical parts. Wiping the faceplate with a hard cloth or using a volatile liquid such as thinner or alcohol may scratch the surface or erase the screened print.

■ Acquiring GPS signal

The first time you turn on this unit, you must wait while the system acquires satellite signals for the first time. This process could take up to several minutes. Make sure your vehicle is outdoors in an open area away from tall buildings and trees for fastest acquisition. After the system acquires satellites for the first time, it will acquire satellites quickly each time thereafter.

■ Caution for Smartphone Users

Simultaneously running multiple applications on your smartphone while screen sharing places heavy demand on the microprocessor of the phone, potentially affecting communication and performance.

For best results while pairing with your KENWOOD receiver, please be sure to close any unused applications.

How to read this manual

- The screens and panels shown in this manual are examples used to provide a clear explanation of operations. For this reason, they may be different from the actual screens or panels, or some display patterns may be different from the actual ones.
- Display language: English is used for the purpose of explanation. You can select a display language from the [SETUP] menu. See **System Setup (P.69)**.
- []: Indicates the name of touch keys.





This symbol on the product means there are important operating and maintenance instructions in this manual. Be sure to carefully read instructions in this manual.

Basic Operations

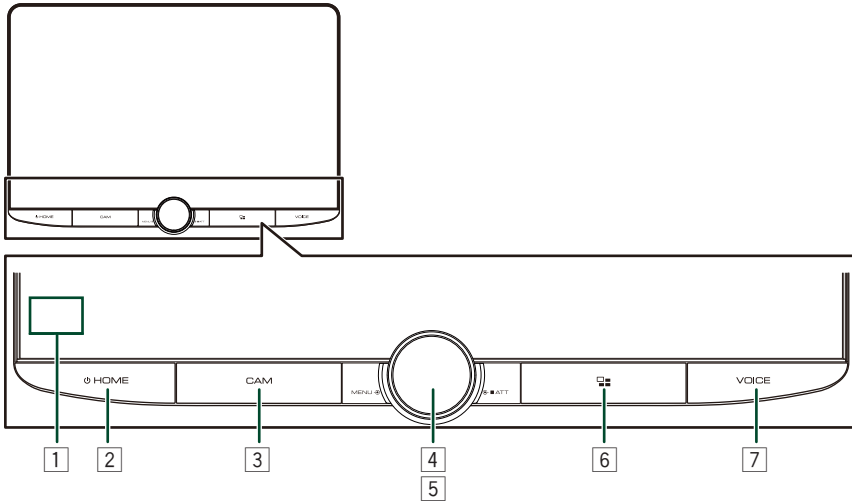
Functions of the Buttons on the Front Panel



Number	Name	Motion
1	Remote Sensor	<ul style="list-style-type: none"> Receives the remote control signal.
2	 HOME	<ul style="list-style-type: none"> Displays the HOME screen. (P.15) When the power is off, turns the power on. Pressing for 1 second turns the power off.
3	CAM	<ul style="list-style-type: none"> Switches view camera display on/off. (P.57) <p>The camera whose view is displayed first changes according to the Camera Assignment Settings (P.58) and the shift lever position in the shift gate. The camera whose view was displayed last is kept and the same camera view will be displayed the next time. If its assignment setting is changed, the rear camera view is displayed.</p>
4	MENU/ATT	<ul style="list-style-type: none"> Displays the popup menu screen. Pressing for 1 second switches attenuation of the volume on/off.
5	Volume knob	<ul style="list-style-type: none"> Adjusts the volume. (P.11)
6		<ul style="list-style-type: none"> Displays the APP (Apple CarPlay, Android Auto, or Wireless Mirroring) screen. While the APP screen is displayed, switches to the control screen of current source.
7	VOICE	<ul style="list-style-type: none"> Switches the voice recognition function on/off. (P.24) (P.26) (P.53) When neither Apple CarPlay, Android Auto, nor a Bluetooth Hands-Free phone is connected, pressing and holding displays Bluetooth pairing waiting dialog. (P.45)

Touch screen operations

To perform operations on the screen, you need to touch, touch and hold, flick or swipe to select an item, display a setting menu screen or change pages.

● Touch

Touch the screen gently to select an item on the screen.

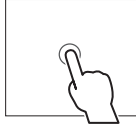

● Touch and hold

Touch the screen and keep your finger in place until the display changes or a message is displayed.

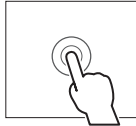

● Flick

Slide your finger quickly to the left or right on the screen to change the page.
You can scroll a list screen by flicking up/down on the screen.



● Swipe

Slide your finger up or down on the screen to scroll the screen.

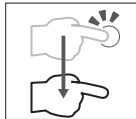

Turning on the Unit

NOTE

- If it is your first time to turn the unit on after installation, it will be necessary to perform Initial SETUP (P.12).

1 Press the HOME button.



The unit is turned on.

● To turn off the unit:

1 Press and hold the HOME button.

The unit is turned off.

Adjusting the volume

You can adjust the volume (0 to 40).
Turn the knob clockwise to increase, and counter-clockwise to decrease.

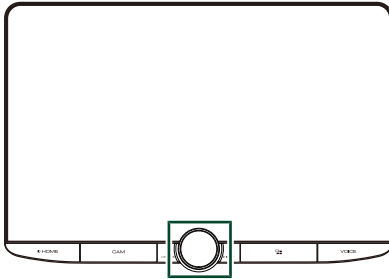

Turn off the screen

- 1 Press the [MENU/ATT] button.
Popup menu appears.
- 2 Touch [Display OFF] on the popup menu.



NOTE

- Touch the display to turn on the screen.
- To display the clock while the screen is off, it is necessary to set "OSD Clock" to "ON". **(P.66)**

Put the unit in standby

- 1 Press the **HOME** button.
HOME screen appears.
- 2 Touch .
- 3 Touch [STANDBY].

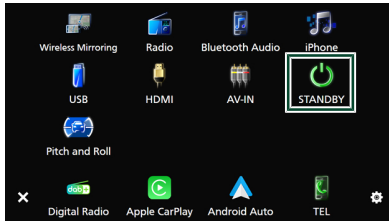

Initial Settings

Initial SETUP

Perform this setup when you use this unit first time.

- 1 Set each item as follows.

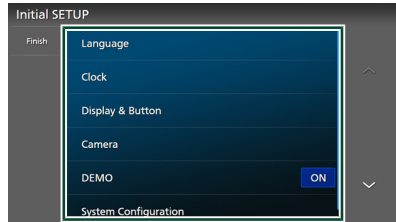

■ [Language]

Select the language used for the control screen and setting items. Default is "British English(en)".

- ① Touch [Language].
- ② Touch [Language Select].
- ③ Select the desired language.
- ④ Touch .

■ [Clock]

Sets the synchronization of the clock. For details, see **Select the time zone and time format (P.14)**.

■ [Display & Button]

Set button illumination color, clock skin, and viewing angle.

If it is hard to see the image on the screen even, adjust the viewing angle.

- ① Touch [Display & Button].
- ② Set each item and touch .

For details, see **Display & Button Setup (P.66)**.

■ [Camera]

Set the parameters for the camera.

- ① Touch [Camera].
- ② Set each item and touch .

For details, see **Camera Setup (P.57)**.

■ [DEMO]

Set the demonstration mode. Default is "ON".

■ [System Configuration]

Configure the digital sound output settings. For details, see **System Configuration settings (P.13)**.

2 Touch [Finish].

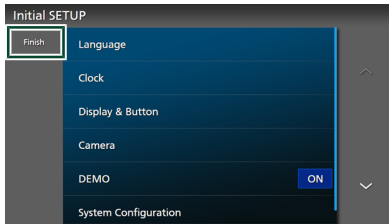

NOTE

- These settings can be made from the SETUP menu. See **Setup (P.63)**.
- When reconfiguring the System Configuration settings, run Initialize from the System Setup. Parameters not included in System Configuration can be configured in SETUP.
- System Configuration settings (except for Built-In Amplifier) can only be configured during Initial Setup.
- When configuring the [Fibre Optic Output] and [Installation Orientation], the system will restart after the [Finish] button is pressed.

System Configuration settings

1 Touch [System Configuration] on the Initial SETUP screen.

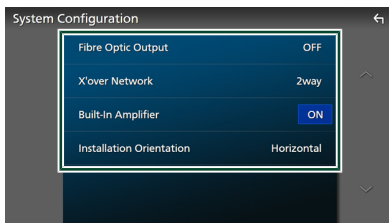

■ [Fibre Optic Output]

Set the output sampling frequency when using optical digital sound output.

- ① Touch [Fibre Optic Output].
- ② Select the output sampling frequency. [OFF] (Default) / [48kHz] / [96kHz]

③ Touch .

Touch [Finish] and a message will appear. Touch [Yes] to restart and apply the settings.

■ [X'over Network]

Set X'over Network to either 2-way or 3-way.

- ① Touch [X'over Network].
- ② Read the message and press [Next].

- ③ Select the crossover network mode. [2way] (Default) / [3way]
- ④ Touch [Yes].

▲ CAUTION

Connecting 3-way speakers with the 2-way mode selected can break the speakers.

NOTE

- When installing a 3-way speaker, make sure to always first run Initialize and go through the user setup. See **System Setup (P.69)**.
- X'Over Network settings are disabled when the [Fibre Optic Output] is set to 48 kHz or 96 kHz.

■ [Built-In Amplifier]

Select whether to use the built-in power amplifier. Turning off the built-in amplifier improves the quality of the sound from Preout.

[ON] (Default) / [OFF]

■ [Installation Orientation]

Set whether the main unit is oriented vertically or horizontally.

① Touch [Installation Orientation].

② Select the orientation.

[Horizontal] (Default) / [Vertical]

③ Touch .

Touch [Finish] and a message will appear. Touch [Yes] to restart and apply the settings.

Security Code Setup

You can set up a security code to protect your receiver system against theft.

When the Security Code function is activated, the code cannot be changed and the function cannot be released. Note the Security Code can be set as the 4 to 8 digit number of your choice.

Preparation

- Set [DEMO] to [OFF] in the System setting menu screen (**P.69**).

1 Press the HOME button.

HOME screen appears.

2 Touch .

3 Touch [SETUP].

SETUP Menu screen appears.

Basic Operations

- 4 Touch [System].**
System setting menu appears.
- 5 Touch [Security Code Set] in the system setting menu.**
Security Code Set screen appears.
- 6 Enter a security code with 4 to 8 digit number and touch [Enter].**

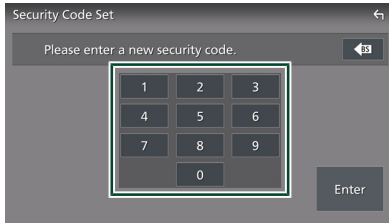

- 7 Enter the same code again and touch [Enter].**
Now, your security code is registered.

NOTE

- Touch [BS] to delete the last entry.
- If you enter a different security code, the screen returns to step **6** (for the first code entry).
- If you have disconnected the Receiver from battery, enter the correct security code as that you have entered in step **6** and touch [Enter]. You can use your receiver.

To change the security code:

- 1 Touch [Security Code Change] on the Security screen.**
Security Code Set screen appears.
- 2 Enter the current registered security code and touch [Enter].**
- 3 Enter a new security code with 4 to 8 digit number and touch [Enter].**
- 4 Enter the same code again and touch [Enter].**
The new security code is registered.

To clear the security code:

- 1 Touch [Security Code Cancellation] on the Security screen.**
Security Code Set screen appears.

- 2 Enter the current registered security code and touch [Enter].**
The security code is cleared.

Select the time zone and time format

- 1 Press the HOME button.**
HOME screen appears.
- 2 Touch .**
- 3 Touch [SETUP].**
SETUP Menu screen appears.
- 4 Touch [System].**
System setting menu appears.
- 5 Set each item as follows.**
Scroll the page to show hidden items.



[Time Format]

Select the time display format.
[12-Hour] / [24-Hour] (Default)

[Time Zone]

Select the time zone.

Display the HOME screen

- 1 Press the **HOME** button.



HOME screen appears.

HOME screen descriptions

Most functions can be performed from the HOME screen.



- 1 _____
Widget **(P.20)**
- 2 _____
Displays the source selection screen. **(P.16)**
- 3 _____
Displays the SETUP Menu screen. **(P.63)**
- 4 _____
Short-cut playback source icons. **(P.16)**

Popup menu

- 1 Press the **[MENU/ATT]** button.



Popup menu appears.

- 2 Touch to display the popup menu.



The contents of the menu are as follows.

	• Displays the Screen Adjustment screen. (P.63)
	• Turns the display off. (P.11)
	• Displays the view camera screen. (P.57)
	• Displays the SETUP Menu screen. (P.63)
	• Displays the Audio screen. (P.71)
	• Displays the control screen of current source. Icon feature differs depending on the source. This icon is for USB source.
	• Close the popup menu.
	• Short-cut source icons: The source changes to the one you have set with a short-cut. For the short-cut setting, refer to Customize Short-cut source icons (P.16) .
	• Displays the Device List screen. (P.45)

Source selection screen description

You can display icons of all playback sources and options on the source selection screen.

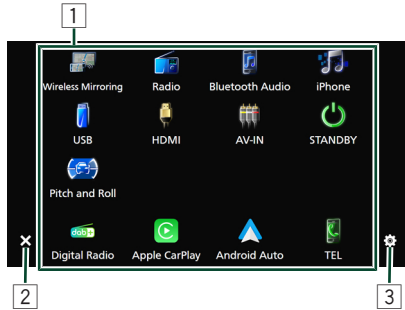

1 _____
Changes playback sources. For playback sources, see **Select the playback source (P.16)**.

2 _____
Returns to the previous screen.

3 _____
Displays the SETUP Menu screen. **(P.63)**

Select the playback source

1 Press the **HOME** button.
HOME screen appears.

2 Touch **[Grid]**.
From the screen, you can select the following sources and functions.

	• Switches to the Digital Radio broadcast. (P.39)
	• Switches to the Apple CarPlay screen from the connected iPhone. (P.22)
	• Switches to the Android Auto screen from the connected Android™ smartphone. (P.24)
	• Displays the Hands-Free screen. (P.51) When neither Apple CarPlay, Android Auto, nor a Bluetooth Hands-Free phone is connected, displays Bluetooth pairing waiting dialog.*1 (P.45)

	• Switches to the Wireless Mirroring screen from the connected Android smartphone. (P.22)
	• Switches to the Radio broadcast. (P.35)
	• Plays a Bluetooth audio player. (P.49)
	• Plays an iPhone. (P.31)
	• Plays files on a USB device. (P.27)
	• Plays a device connected to the HDMI input terminal. (P.61)
	• Switches to an external component connected to the AV Audio input and the Video input terminal.*2 *3 (P.60)
	• Puts the unit in standby. (P.12)
	• Switches to the Pitch and Roll screen. (P.62)

*1 When connecting as Apple CarPlay or Android Auto, it works as a phone provided in Apple CarPlay or Android Auto. If Apple CarPlay or Android Auto are connected during talking by the Bluetooth device, the current call will be continued.

*2 You can use the [AV-IN] source when a cable from a visual source except a camera is connected to the Video input terminal, and a cable is connected to the AV Audio input terminal. **(P.95)**

*3 Set "VIDEO IN" to "None" in Camera Assignment Settings. **(P.58)**

Customize Short-cut source icons

You can arrange the positions of the source icons as you like.

The 4 items placed in bottom line will appear on the bottom bar in various screens, as the short-cut playback source icons.

1 Press the **HOME** button.
HOME screen appears.

2 Touch **[Grid]**.

3 Touch and hold the icon which you want to move in the customizing mode.

4 Drag the icon to the desired position.



Source control screen descriptions

There are some functions which can be performed from most screens.

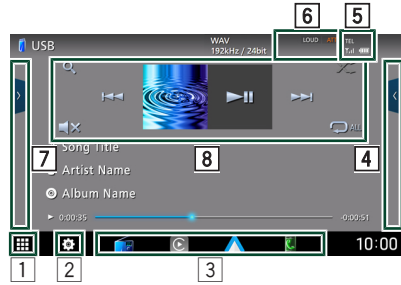

Displays the source selection screen. (P.16)



Displays the SETUP Menu screen. (P.63)

3 Short-cut source icons

The source changes to the one you have set with a short-cut. For the short-cut setting, refer to **Customize Short-cut source icons (P.16)**.

4 Function panel *

Touch the right side of the screen to display the function panel. Touch again to close the panel.



Connected Bluetooth device information.

6 Indicator items

Displays the current source condition and so on.

- “ATT”: The attenuator is active.
- “MUTE”: The mute function is active.
- “LOUD”: The loudness control function is active.

7 Content list *

Displays the track/file/station/channel list.

Basic Operations

8 Operation keys

You can operate the current source with these operation keys. The available functions are different depending on the source type.

* For right hand drive vehicles, the left and right drawers are swapped. For how to set up the driving position, see **User Interface Setup (P.68)**.

List screen

There are some common function keys in the list screens of most sources. **(P.29) (P.33) (P.50)**

Display the list screen

● For USB/iPhone:

1 Touch **Q** or the item listed on the information area in the source control screen.

The list screen appears.

● For Bluetooth audio:

1 Touch **Q**.

The list screen appears.

You can use following operation keys from this screen.

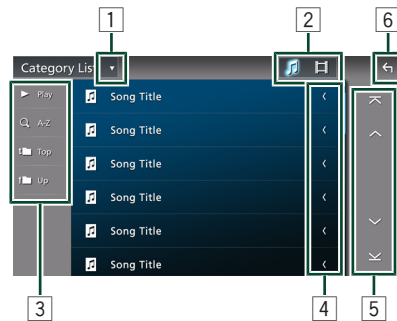

1 ▼

Displays the list type selection window.

2 🎵 📺

Displays a music/movie file list.

3 ▶ **Play** etc.



Keys with various functions are displayed here.



- ▶ **Play**: Plays all tracks in the folder containing the current track.
- Q A-Z**: Jumps to the letter you entered (alphabetical search).
- 📁 Top** **📁 Up**: Moves to the upper hierarchy level.

4  **Text scroll**

Scrolls the displayed text.

5  /  /  /  **Page scroll**

You can change pages to display more items by touching  / .

-  /  : Displays the top or bottom page.

6  **Return**

Returns to the previous screen.

NOTE

- Depending on the current source or mode, some function key may not appear.

Widget

Widget

- 1 Press the **HOME** button.
HOME screen appears.
- 2 You can change the widget or customize the widget area.

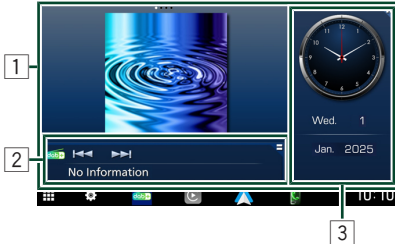

Photo Frame Widget

You can display a slideshow of the image files stored in your iPhone or Android smartphone.



Preparation

- See **Importing Image Files (P.21)**.

1 Full screen widget panel

You can change the full screen panel widget by flicking left or right on the widget panel. The widget is switched in the following sequence: Album Art, Pitch and Roll, Visualizer, Photo Frame.

2 Flexible source widget panel

- Displays the current source information and operation keys.
- While playing an audio source, you can switch the widget panel size between 2-line and 4-line by touching the right top corner of the widget panel.
-  (USB/HDMI/AV-IN/Wireless Mirroring source only):
Displays the source control screen.
-  (HDMI/AV-IN/Wireless Mirroring source only):
Switches the widget panel orientation between horizontal and vertical.

3 Drive widget panel

You can change the drive panel widget by touching the right top corner of the widget panel. **(P.21)**

Drive Widget Panel

You can change the widget.

- 1 Press the **HOME** button.
HOME screen appears.
- 2 Touch the right top corner of the drive widget panel.

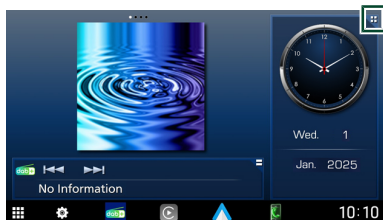

The drive widget list appears.

- 3 Touch the desired widget.
 - You can select from the following widgets.
 - Clock Widget
 - Compass Widget
 - EQ Setting Widget
 - Camera Widget

To change the widget position

You can change the widget panel position to right or left. If the drive widget panel position is changed, the full screen widget panel position and flexible source widget panel position are also changed.

- 1 Touch and hold the drive widget panel.
Widget customize mode is activated.

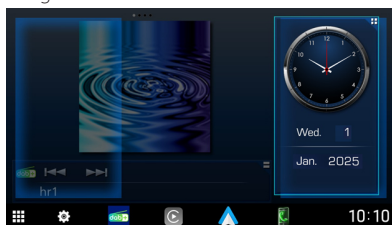

- 2 Drag the drive widget to right or left.

Importing Image Files

You can display image files stored in your iPhone or Android smartphone by connecting your iPhone or Android smartphone in which the "KENWOOD Portal APP" application is installed to this unit.

The image files are displayed on the photo frame widget. Also, you can set an image as the wallpaper.

See **Photo Frame Widget (P.20)** and **To register an original image (P.68)**.

Preparation

- Install the latest version of the "KENWOOD Portal APP" application on your iPhone or Android smartphone.
 - iPhone: Search for "KENWOOD Portal APP" in the Apple App Store to find and install the most current version.
 - Android smartphone: Search for "KENWOOD Portal APP" in Google Play to find and install the most current version.
- For details, see "KENWOOD Portal APP" application.

- 1 Connect the device.
 - To connect a device via Bluetooth, register it as the Bluetooth device and do the App (SPP) profile setting of the connection beforehand. See **Register the Bluetooth device (P.45)** and **Switch the connected device (P.46)**.
 - Connect your iPhone with the USB cable that matches the connector. **(P.96)**

- 2 Unlock your device.

APPS

Wireless Mirroring Operation

You can display the same screen of the Android smartphone on the monitor of the unit using the Wireless Mirroring function of the Android smartphone.

Preparation

- You can use the Wireless Mirroring function with Android smartphones compatible with this function.
- This function may be called Wireless Display, Screen Mirroring, AllShare Cast, etc., depending on the manufacturer.
- The settings on the Android smartphone differ depending on the device type. For details, refer to the instruction manual supplied with your Android smartphone.
- If your Android smartphone is locked, Mirroring screen may not appear.
- If the Android smartphone is not ready for UIBC, you cannot perform touch operation.

- 1 Press the  HOME button.**
HOME screen appears.
- 2 Touch .**
- 3 Touch [Wireless Mirroring]. (P.16)**
The App screen is displayed.
- 4 Operate your Android smartphone to activate the Wireless Mirroring function, then connect to this unit.**
- 5 Select ("DMX9724XDS") as the network to use.**
When the connection is established, then the same screen displayed on the Android smartphone is displayed.

NOTE

- Apps is discontinued when the power is turned ON/OFF or you leave the vehicle. To restart Apps, operate the Android smartphone.
- When the Apps source is displayed, you cannot register or reconnect a Bluetooth device. Switch the Apps source to another source, and then operate the Bluetooth device.

Apple CarPlay Operation

Apple CarPlay is a smarter, safer way to use your iPhone in the car. Apple CarPlay takes the things you want to do with iPhone while driving and displays them on the screen of the product. You can get directions, make calls, send and receive messages, and listen to the music from iPhone while driving. You can also use Siri voice control to make it easier to operate iPhone. For details about Apple CarPlay, visit <https://www.apple.com/ios/carplay/>.

Compatible iPhone devices

You can use Apple CarPlay with the following iPhone models.

- iPhone 15 Pro Max
- iPhone 15 Pro
- iPhone 15 Plus
- iPhone 15
- iPhone SE(3rd generation)
- iPhone 14 Pro Max
- iPhone 14 Pro
- iPhone 14 Plus
- iPhone 14
- iPhone 13 Pro Max
- iPhone 13 Pro
- iPhone 13 mini
- iPhone 13
- iPhone 12 Pro Max
- iPhone 12 Pro
- iPhone 12 mini
- iPhone12
- iPhone 11 Pro Max
- iPhone 11 Pro
- iPhone 11
- iPhone XS Pro
- iPhone XS
- iPhone XR
- iPhone X
- iPhone SE(2nd generation)

Connecting an iPhone

Wired connection

- 1 Connect your iPhone with the USB cable that matches the connector. (P.96)**
When an iPhone compatible with Apple CarPlay is connected to the USB terminal, the Bluetooth Hands-Free phone currently connected is disconnected. If another Bluetooth Hands-Free phone is being used, disconnection will occur after ending the call.
- 2 Unlock your iPhone.**

NOTE

- Depending on the iPhone connector, use a genuine Apple Lightning-USB cable or a USB-IF certified USB-C® to USB-A USB cable. If you use non-certified cable, it may not work properly.

Wireless connection

You can select the iPhone registered in [Device List] and use it as the Apple CarPlay device. See **Register the Bluetooth device (P.45)**.

NOTE

- Turn on the Bluetooth function and Wi-Fi function of an iPhone.
- If two or more iPhone have been registered, select the iPhone to be used as the [Apple CarPlay] source. See **Switch the connected device (P.46)**.
- It is necessary to connect the GPS antenna in order to use a wireless Apple CarPlay.
- When the Wi-Fi connection becomes unavailable, the HOME screen is displayed.
- You cannot use Apple CarPlay if the function is turned off by operating the iPhone at functional setup.

To switch the Current Screen to the Apple CarPlay Screen When Connecting Your iPhone

- Touch [Apple CarPlay] icon on the source selection screen. **(P.16)**
- or
- Touch the following connection message if the message appears.

**NOTE**

- The connection message appears when;
 - The iPhone you used previously is connected again.
 - The screen other than HOME and the source selection screen is displayed.
- The connection message is displayed for about 5 seconds.

Operation keys and available Apps on the home screen of Apple CarPlay

You can use the Apps of the connected iPhone. The items displayed and the language used on the screen differ among the connected devices.

To enter the Apple CarPlay mode, touch [Apple CarPlay] icon on the source selection screen. **(P.16)**

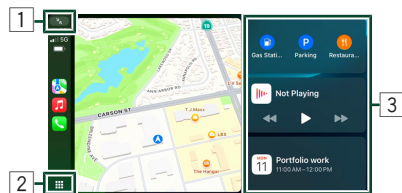

Switches between Full screen and Split screen on the Apple CarPlay screen.



- Displays the home screen of Apple CarPlay.
- Touch and hold to activate Siri.

3 Application keys

Starts the application.

* The icon design may change depending on the iOS version.

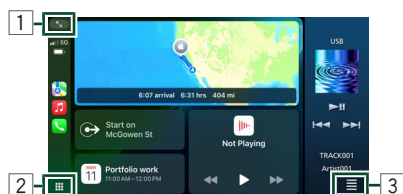
Apple CarPlay split screen

Switches between Full screen and Split screen on the Apple CarPlay screen.



- Displays the home screen of Apple CarPlay.
- Touch and hold to activate Siri.



The source selection screen is displayed. The source can be switched while staying in the split screen mode.

APPS

* The icon design may change depending on the iOS version.

To exit the Apple CarPlay screen

- 1 Press the **HOME** button.

Use Siri

You can activate Siri.

- 1 Press the **[VOICE]** button.

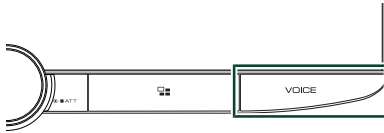

- 2 Talk to Siri.

To deactivate

- 1 Press the **[VOICE]** button.

Switch to the Apple CarPlay screen while listening to another source

- 1 Press the **[SOURCE]** button.

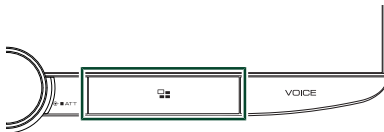

NOTE

- When listening to another source with the Apple CarPlay screen displayed, playing music in the Apple CarPlay mode will switch the current source to the Apple CarPlay source.

Android Auto™ Operation

Android Auto enables you to use the functions of your Android smartphone convenient for driving. You can easily access route guidance, make calls, listen to music, and access convenient functions on the Android smartphone while driving.

For details about Android Auto, visit <https://www.android.com/auto/> and <https://support.google.com/androidauto>.

Compatible Android smartphones

Compatible Android phone and compatible active data plan required. To wirelessly use Android Auto on your car display, you need a compatible Android smartphone with an active data plan. You either need:

1. A smartphone with Android 11 or higher and 5 GHz Wi-Fi (subject to local regulations*); or
2. An Android or Samsung smartphone with Android 10; or
3. A Samsung Galaxy S8, Galaxy S8+, or Note 8, with Android 9

NOTE

- Android Auto may not be available on all devices and may not be available in all countries or regions.

About the placement of smartphone

Install the smartphone connected as Android Auto device in the place where it can receive the GPS signals.

When using Google Assistant, install the smartphone in the place where the smartphone easily catch a voice by the microphone.

NOTE

- Do not put the smartphone in a spot exposed to direct sunlight or near an air blowing out port of an air conditioner. The placement of the smartphone in such places can lead to malfunction or damage of your smartphone.
- Do not leave the smartphone in the vehicle.



Connect Android smartphone

Wired connection

- 1 **Connect an Android smartphone via the USB terminal. (P.96)**
To use the Hands-Free function, connect the Android smartphone via Bluetooth. When an Android smartphone compatible with Android Auto is connected to the USB terminal, the device is connected via Bluetooth automatically, and the Bluetooth Hands-Free phone currently connected is disconnected.
- 2 **Unlock your Android smartphone.**
- 3 **Press the  HOME button.**
HOME screen appears.
- 4 **Touch .**
- 5 **Touch [Android Auto]. (P.16)**

Wireless connection

You can select the Android smartphone registered in [Device List] and use it as the Android Auto device. See **Register the Bluetooth device (P.45)**.

- 1 **Press the  HOME button.**
HOME screen appears.
- 2 **Touch .**
- 3 **Touch [Android Auto]. (P.16)**

NOTE

- Turn on the Bluetooth function and Wi-Fi function of Android smartphone.
- If two or more Android smartphones have been registered, select the Android smartphone to be used as the Android Auto source. See **Switch the connected device (P.46)**.
- To change the password for wireless connection manually, refer to [Reset Android Auto Wireless Connection] **(P.65)**.
- When the Wi-Fi connection becomes unavailable, the HOME screen is displayed.

Operation keys and available Apps on the Android Auto screen

You can perform the operations of the Apps of the connected Android smartphone. The items displayed on the screen differ among the connected Android smartphones. To enter the Android Auto mode, touch the [Android Auto] icon on the source selection screen. **(P.16)**

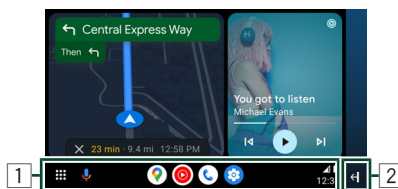

1 Navigation bar *1

Starts the application or displays information.

2 Switch screen *2

Switches between Full screen and Split screen on the Android Auto screen.

Android Auto split screen

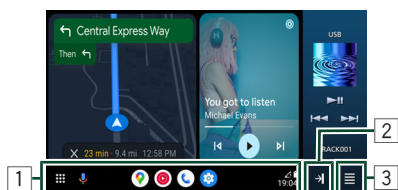

1 Navigation bar *1

Starts the application or displays information.

2 Switch screen *2

Switches between Full screen and Split screen on the Android Auto screen.

3

The source selection screen is displayed. The source can be switched while staying in the split screen mode.

APPS

- *1 The icon design may change depending on the Android OS version.
- *2 To switch to Split screen, set [Android Auto Screen Size Switching] to on. **(P.68)**

NOTE

- The  will be on the left or right depending on the drive position settings. **(P.68)**
- The items displayed and the language used on the screen differ among the connected devices.

To exit the Android Auto screen

- 1 Press the  HOME button.

Using voice control

- 1 Press the [VOICE] button.

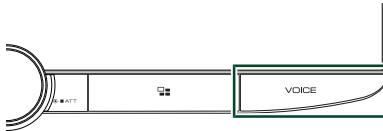

- 2 Start speaking.

NOTE

- When you press and hold the [VOICE] button while inputting voice, you can start over from the beginning.

To cancel

- 1 Press the [VOICE] button.

Switch to the Android Auto screen while listening to another source

- 1 Press the  button.

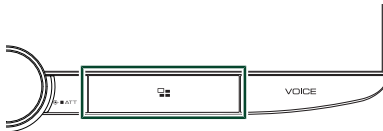

NOTE

- When listening to another source with the Android Auto screen displayed, playing music in the Android Auto mode will switch the current source to the Android Auto source.

USB

Connecting a USB device

- 1 Connect the USB device with the USB cable. (P.96)

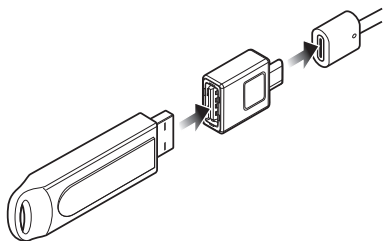

- 2 Press the **HOME** button.
HOME screen appears.

- 3 Touch .

- 4 Touch [USB]. (P.16)

Disconnect the USB device

- 1 Press the **HOME** button.
HOME screen appears.

- 2 Touch a source other than [USB].

- 3 Detach the USB device.

Usable USB device

You can use a mass-storage-class USB device with this unit.

The word "USB device" appearing in this manual indicates a flash memory device.

● About the file system

The file system should be the one of the following.

- FAT16
- FAT32
- exFAT
- NTFS

NOTE

- Install the USB device in the place where it will not affect safe driving.
- You cannot connect a USB device via a USB hub and Multi Card Reader.
- Take backups of the audio files used with this unit. The files can be erased depending on the operating conditions of the USB device. We shall have no compensation for any damage arising from any erased data.

USB Basic Operation

Most functions can be controlled from the source control screen and playback screen.

NOTE

- Set the remote controller mode switch to AUD mode before starting operation, see **Switch the operation mode (P.82)**.

Control screen



Open the drawer

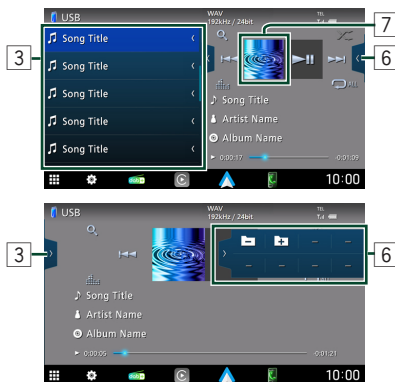

1 CODEC

When a high-resolution source is played, its format information is displayed.

2 Operation keys

- Q** : Searches track/file. For details on search operation, see **Search Operation (P.29)**.
- ◀◀▶▶** : Searches the previous/next track/file.
Touch and hold to fast forward or fast backward. (It will be cancelled automatically after about 50 seconds.)
- ▶||** : Plays or pauses.

- 📊** : Displays the Graphic Equalizer screen. **(P.73)**
- 🔄** : Repeats the current track/folder. Each time you touch the key, repeat modes are switched in the following sequence:
File repeat (**🔄**), Folder repeat (**📁**), Repeat all (**🔄 ALL**)
- 🎲** : Randomly plays all tracks in the current folder. Each time you touch the key, random modes are switched in the following sequence:
Folder random (**📁**), Random off (**🎲**)

3 Content list

- Touch the left side of the screen to display the Content list. Touch again to close the list.
- Displays the playing list. When you touch a track/file name on the list, playback will start.

4 Track information

Displays the information on the current file. Only a file name and a folder name are displayed if there is no tag information.

5 Play mode indicator/Playing time

- ▶, ▶▶, etc.**: Current play mode indicator
Meanings of individual icons are as follows:
- ▶** (play), **▶▶** (fast forward), **◀◀** (fast backward), **||** (pause).
- For confirmation of current playing position. You can drag the circle left or right to change the playing position.



6 Function panel

Touch the right side of the screen to display the function panel. Touch again to close the panel.

- [-] [+]** : Searches for the previous/next folder.

7 Artwork

The jacket of the currently playing file is displayed.

Video screen



8 File search area (Video file only)

Touch to search for the next/previous file.

9 Key display area (Video file only)

Touch to display the control screen.

Control screen

Video file

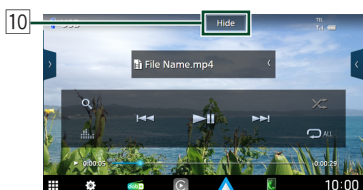

10 Hide (Video file only)

Hides the control screen.

Search Operation

You can search music or video files by the following operations.

1 Touch Q.

2 Touch ▾.



3 Select a list type.

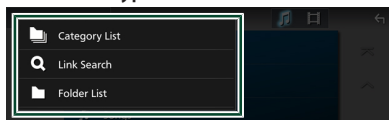



NOTE

- For operations on the list screen, see **List screen (P.18)**.

Category search

You can search for a file by selecting a category.

1 Touch [Category List].

2 Select whether you search audio files  or video files .

3 Touch the desired category.

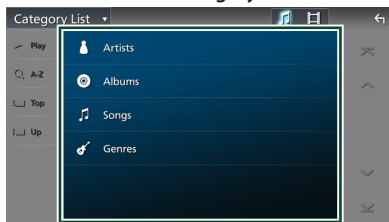

The list corresponding to your selection appears.

4 Touch to select the desired item in the list. Repeat this step until you find the desired file.

Link search (Audio file only)

You can search for a file of the same artist/album/genre as that in the current track.

USB

- 1 Touch [Link Search].
- 2 Touch the desired tag type. You can select from artists, albums and genres.

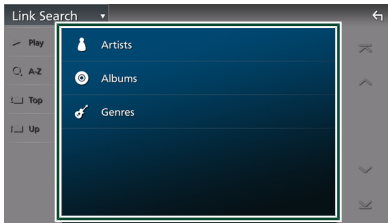

The list corresponding to your selection appears.

- 3 Touch the desired item in the content list.

Folder search

You can search for a file according to hierarchy.

- 1 Touch [Folder List].
- 2 Touch the desired folder.

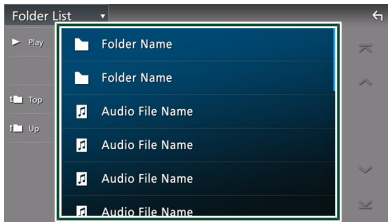

When you touch a folder its contents are displayed.

- 3 Touch to select your desired item in the list. Repeat this step until you find the desired file.

iPhone

Preparation

Connectable iPhone

The following models can be connected to this unit.

Made for

- iPhone 15 Pro Max
- iPhone 15 Pro
- iPhone 15 Plus
- iPhone 15
- iPhone SE(3rd generation)
- iPhone 14 Pro Max
- iPhone 14 Pro
- iPhone 14 Plus
- iPhone 14
- iPhone 13 Pro Max
- iPhone 13 Pro
- iPhone 13 mini
- iPhone 13
- iPhone 12 Pro Max
- iPhone 12 Pro
- iPhone 12 mini
- iPhone12
- iPhone 11 Pro Max
- iPhone 11 Pro
- iPhone 11
- iPhone XS Pro
- iPhone XS
- iPhone XR
- iPhone X
- iPhone SE(2nd generation)

NOTE

- By connecting your iPhone to this unit with the USB cable, you can supply power to your iPhone as well as charge it while playing music. Note that the power of this unit must be held on.
- If you restart playback after connecting the iPhone, the music that has been played by the iPhone is played first.

Connect iPhone

Wired connection

Preparation

- Connect an iPhone with the USB cable while Apple CarPlay is not connected.
- With an iPhone compatible with Apple CarPlay, turn off Apple CarPlay by operating the iPhone at functional setup before connecting iPhone. For details of the setup method, contact the manufacturer of the terminal.
- Only one iPhone can be connected.
- Depending on the iPhone connector, use a genuine Apple Lightning-USB cable or a USB-IF certified USB-C® to USB-A USB cable. If you use non-certified cable, it may not work properly.

1 Connect your iPhone with the USB cable that matches the connector. (P.96)

2 Press the  HOME button.
HOME screen appears.

3 Touch .

4 Touch [iPhone]. (P.16)

● **To disconnect the iPhone connected with the cable:**

1 Detach the iPhone.

Bluetooth connection

Pair the iPhone through Bluetooth.

Preparation

- To connect an iPhone via Bluetooth, register it as a Bluetooth device and do the profile setting for the connection beforehand. See **Register the Bluetooth device (P.45)** and **Switch the connected device (P.46)**.
- Connect an iPhone via Bluetooth while Apple CarPlay and an iPhone are not connected via USB.
- With an iPhone compatible with Apple CarPlay, turn off Apple CarPlay by operating the iPhone at functional setup before connecting iPhone. For details of the setup method, contact the manufacturer of the terminal.

2 Content list

- Touch the left side of the screen to display the Content list. Touch again to close the list.
- Displays the playing list. When you touch a track/file name on the list, playback will start.

NOTE

- The Content list is not displayed unless you select a file from the category list and play it. To use the category list, see **Search Operation (P.33)**.

3 Track information

- Displays the information on the current file.
- Touch to display the category list screen. See **Category search (P.33)**.

4 Play mode indicator/Playing time

- ▶, ▶▶, etc.: Current play mode indicator
Meanings of individual icons are as follows:
▶ (play), ▶▶ (fast forward), ◀◀ (fast backward), || (pause).
- For confirmation of current playing position. You can drag the circle left or right to change the playing position.



5 Artwork

The jacket of the currently being played file is displayed.

Search Operation

You can search music files by the following operations.

1 Touch Q.

2 Touch ▼.



3 Select a list type.



NOTE

- For operations on the list screen, see **List screen (P.18)**.

Category search

You can search for a file by selecting a category.

1 Touch [Category List].

2 Touch the desired category.

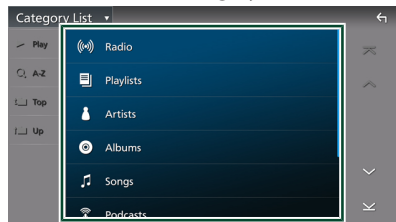

The list corresponding to your selection appears.

3 Touch to select the desired item in the list. Repeat this step until you find the desired file.

Link search

You can search for a file of the same artist/album/genre/composer as that in the current track.

1 Touch [Link Search].

iPhone

- 2 Touch the desired tag type. You can select from artists, albums, genres and composers.

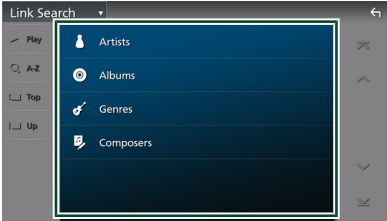

The list corresponding to your selection appears.

- 3 Touch the desired item in the content list.

Radio

Radio Basic Operation

Most functions can be controlled from the source control screen.

To listen to the Radio source, touch [Radio] icon on the source selection screen. (P.16)

NOTE

- Set the remote controller mode switch to AUD mode before starting operation, see **Switch the operation mode (P.82)**.

Control screen

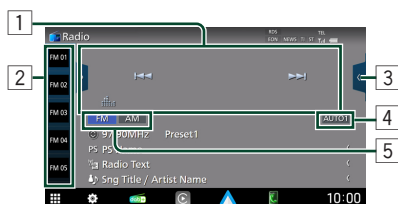

Open the drawer

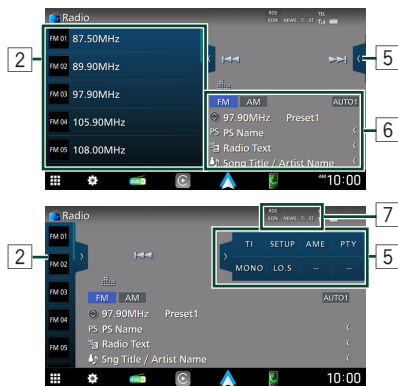

1 Operation keys

- ◀◀▶▶: Tunes in a station. The method of switching frequencies can be changed (see 4 Seek mode).
- 📊: Displays the Graphic Equalizer screen. (P.73)

2 Preset list

- Touching ◀ / ▶ allows you to change the display size.

- Recalls the memorized station.
- When touched for 2 seconds, stores the currently being received station in the memory.

3 Band keys

Switches bands (between FM and AM).

4 Seek mode

Touch to switch seek mode in the following sequence: [AUTO1], [AUTO2], [MANUAL].

- [AUTO1]: Tunes in a station with good reception automatically.
- [AUTO2]: Tunes in the memorized stations one after another.
- [MANUAL]: Switches to the next frequency manually.

5 Function panel

Touch the right side of the screen to display the function panel. Touch again to close the panel.

- [TI] (FM only) : Selects the traffic information mode. For details, see **Traffic Information (P.37)**.
- [SETUP] (FM only) : Displays the Radio SETUP screen. For details, see **Radio SETUP (P.38)**.
- [AME] : Presets stations automatically. For details, see **Auto memory (P.36)**.
- [PTY] (FM only) : Searches for a program by program type. For details, see **Search by program type (P.37)**.
- [MONO] (FM only) : Selects the Monaural reception mode.
- [LO.S] (FM only) : Turns the Local Seek function on or off.

6 Information display

Displays the information on the current station: Frequency

Touching  allows you to switch between Content A and Content B.

- Content A: PS name, Radio Text, Title & Artist
- Content B: PTY Genre, Radio Text plus **Preset#**: Preset number

Radio

7 Indicator Items

- “RDS”: Indicates the state of the Radio Data System station when the AF function is on.
 - White: Radio Data System is being received.
 - Orange: Radio Data System is not being received.
- “EON”: The Radio Data System station is sending EON.
- “NEWS”: News bulletin interruption is in progress.
- “TI”: Indicates the reception state of traffic information.
 - White: TP is being received.
 - Orange: TP is not being received.
- “ST”: A stereo broadcast is being received.

Memory Operation

Auto memory

You can store stations with good reception in the memory automatically.

1 Touch desired band key.



2 Touch [AME] on the right side of the screen. Touch [AME].

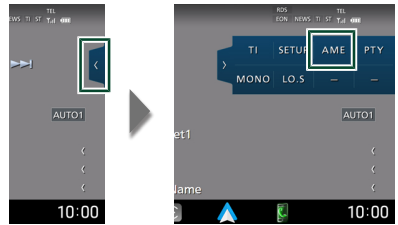

3 Touch [Yes].

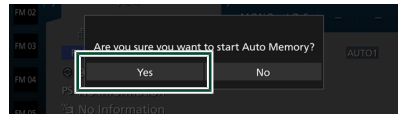

Auto memory starts.

Manual memory

You can store the currently being received station in the memory.

1 Select the station you wish to store in the memory.

2 Touch [FM#] (#:1-15) or [AM#] (#:1-5) in which you want to store the station for 2 seconds until a beep sounds.

Selecting Operation

Preset select

You can list and select memorized stations.

- 1 Touch  on the left side of the screen. Select a station from the list.

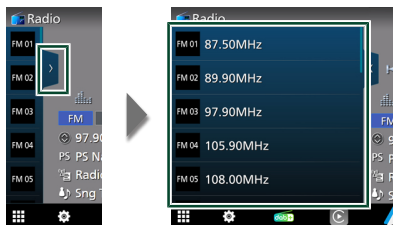

Search by program type

(FM only)

You can tune in the station broadcasting the specified type of program when listening to FM.

- 1 Touch  on the right side of the screen. Touch [PTY].

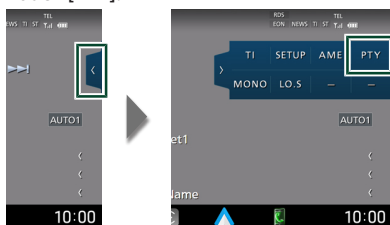

PTY Search screen appears.

- 2 Select a program type from the list.
- 3 Touch [Search].

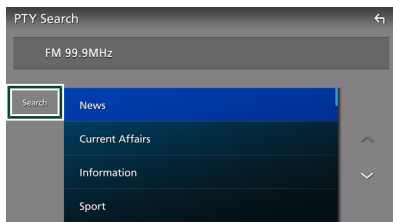

You can search for the station broadcasting the selected type of program.

Traffic Information

(FM only)

You can listen to and watch traffic information automatically when a traffic bulletin starts. However, this feature requires a Radio Broadcast Data System that includes TI information.

- 1 Touch  on the right side of the screen. Touch [TI].

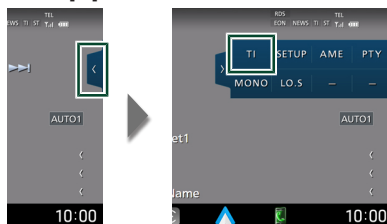

Traffic information mode is set.

When the traffic bulletin starts

The Traffic Information screen appears automatically.

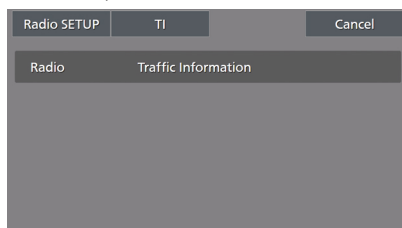

NOTE

- It is necessary to turn on the Traffic Information function in order to allow the Traffic Information screen to appear automatically.
- The volume setting made during reception of traffic information is automatically memorized. When the traffic information is received next time, this unit recalls the volume setting automatically.
- To cancel Traffic Information: Touch [Cancel].

Radio SETUP

(FM only)

You can set tuner related parameters.

- 1 Touch **[<]** on the right side of the screen. Touch **[SETUP]**.



Radio SETUP screen appears.

- 2 Set each function as follows.

■ [NEWS]

Sets a news bulletin interrupt time. Default is "OFF".

■ [AF]

When station reception is poor, automatically switches to the station that is broadcasting the same program over the same Radio Data System network. Default is "ON".

■ [Regional]

Sets whether to switch to the station only in the specific region using the "AF" control. Default is "ON".

■ [Auto TP Seek]

When traffic information station reception is poor, automatically searches for a station that can be received better. Default is "ON".

■ [Language Select]

Selects a display language for the PTY function.

Digital Radio

Digital Radio Basic Operation

Most functions can be controlled from the source control screen.

To listen to Digital Radio source, touch [Digital Radio] icon on the source selection screen. (P.16)

NOTE

- Set the remote controller mode switch to AUD mode before starting operation, see **Switch the operation mode (P.82)**.

Control screen

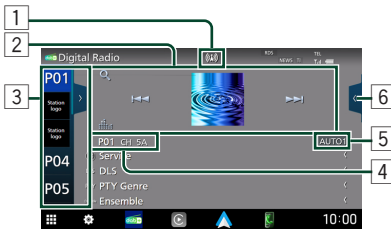

Open the drawer

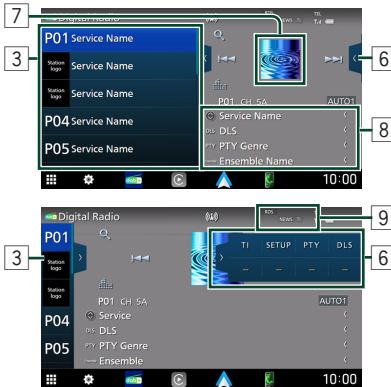

1 Indicator display

Displays the received signal strength.

2 Operation keys

- Q** : Displays the Service List screen. For details on search operation, see **Service search (P.41)**.

- ◀▶▶▶**: Tunes in a ensemble, service, and component. The seek mode switching can be changed. (see **5** Seek mode).
- 📊** : Displays the Graphic Equalizer screen. (P.73)

3 Preset list

- Touching **◀▶** allows you to change the display size.
- Recalls the memorized service.
- When touched for 2 seconds, stores the currently being received service in the memory.

4 Indicator display

P#: Preset number
CH#: Channel display

5 Seek mode

Touch to switch seek modes in the following sequence: [AUTO1], [AUTO2], [MANUAL].

- [AUTO1]: Tunes in a ensemble with good reception automatically.
- [AUTO2]: Tunes in the memorized ensemble one after another.
- [MANUAL]: Switches to the next ensemble manually.

6 Function panel

Touch the right side of the screen to display the function panel. Touch again to close the panel.

- [TI]: Selects the traffic information mode. For details, see **Traffic Information (P.42)**.
- [SETUP]: Displays the Digital Radio SETUP screen. For details, see **Digital Radio SETUP (P.42)**.
- [PTY]: Searches for a program by program type. For details, see **Search by program type (P.41)**.
- [DLS]: Display the Dynamic Label Segment screen.

7 Artwork

The picture data is displayed if available from current content.

Digital Radio

8 Information display

Displays the information on the current station: Service Name

Touching  allows you to switch between Content A, Content B and Content C.

- Content A: DLS, PTY Genre
- Content B: Song Title, Artist Name, Ensemble name
- Content C: Now Playing, Next Program, Audio Quality

Touch to switch between the Control and Information screen.

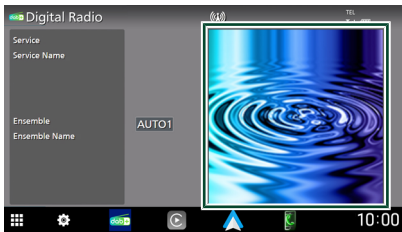

9 Indicator Items

- “RDS”: Radio Data System is being received.
- “NEWS”: News bulletin interruption is in progress.
- “TI”: Indicates the reception state of traffic information.
 - White: TP is being received.
 - Orange: TP is not being received.

Storing Service in Preset Memory

You can store the current receiving service in the memory.

- 1 Select a service you wish to store in memory.
- 2 Touch  on the left side of the screen.

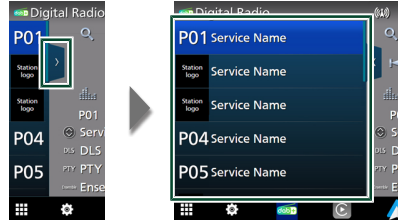

- 3 Touch [P#] (#:1-15) in which you want to store the station for 2 seconds until a beep sounds.

Selecting Operation

Search by program type

You can tune in the station broadcasting the specified type of program when listening to Digital Radio.

- 1 Touch **<** on the right side of the screen. Touch [PTY].

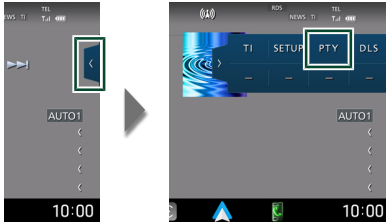

PTY Search screen appears.

- 2 Select a program type from the list.

- 3 Touch [Search].

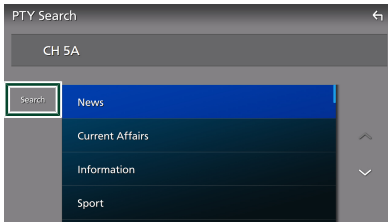

You can search for the station broadcasting the selected type of program.

Service search

You can select a service from a list of all services received.

- 1 Touch **Q**.

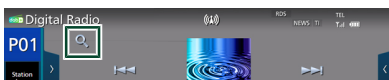

- 2 Select the desired content from the list.

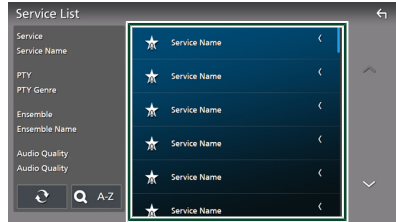

Touch and hold to find the latest service list.



Displays the keyboard screen.

Jump to the letter you entered (alphabet search).

Traffic Information

You can listen to and watch traffic information automatically when a traffic bulletin starts. However, this feature requires a Digital Radio that includes TI information.

- 1 Touch **<** on the right side of the screen. Touch [TI].

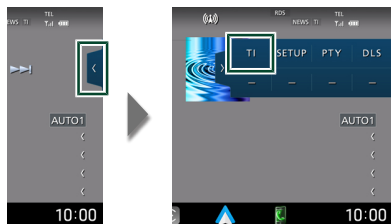

Traffic information mode is set.

When the traffic bulletin starts

The Traffic Information screen appears automatically.

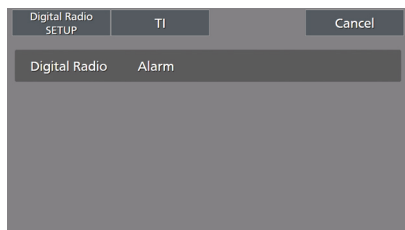

NOTE

- It is necessary to turn on the Traffic Information function in order to allow the Traffic Information screen to appear automatically.
- The volume setting made during reception of traffic information is automatically memorized. When the traffic information is received next time, this unit recalls the volume setting automatically.
- To cancel Traffic Information: Touch [Cancel].

Digital Radio SETUP

You can set Digital Radio related parameters.

- 1 Touch **<** on the right side of the screen. Touch [SETUP].

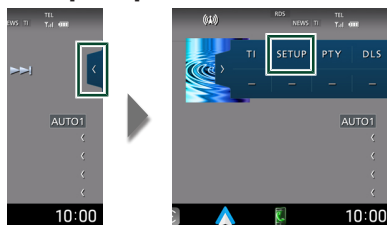

Digital Radio SETUP screen appears.

- 2 Set each function as follows.

■ [Priority]

If the same service is provided by Digital Radio during Radio Data System reception, automatically switches to Digital Radio. If the same service is provided by Radio Data System when reception of the service being provided by Digital Radio becomes poor, automatically switches to Radio Data System.

■ [PTY Watch]

If the service of the set program type begins with the ensemble being received, switches from any source to Digital Radio for service reception.

■ [Announcement Select]

Switches to the set Announcement service. For details, see **Announcement setup (P.43)**.

■ [Antenna Power]

Sets power supply to the Digital Radio antenna. Set to "ON" when the Digital Radio antenna in use is equipped with a booster. Default is "ON".

■ [Related Service]

When you select ON, the unit switches to a related service (if exists) when a Digital Radio service network is not available. Default is "OFF".

■ [Language Select]

Selects a display language for the PTY function.

Announcement setup

When the service for which ON is selected starts, switches from any source to Announcement to receive it.

1 Touch [Announcement Select] on the Digital Radio SETUP screen.

The Announcement Select screen appears.

2 Touch each Announcement list and set on or off.



[Select All]

Turn on all announcements.

[Deselect All]

Turn off all announcements.

NOTE

- The volume setting during reception of Announcement service is automatically stored. The next time the Announcement service is received, this unit recalls the volume setting automatically.

Bluetooth Control

Using the Bluetooth function allows you to use various functions such as listening to the audio file and making/receiving a call.

Information for using Bluetooth® devices



Bluetooth is a short-range wireless radio communication technology for mobile devices such as smartphones/cell-phones, portable PCs, and other devices.

Bluetooth devices can be connected without cables and communication with each other.

NOTE

- While driving, do not perform complicated operations such as dialing numbers, using the phonebook, etc. When you perform these operations, stop your car in a safe place.
- Some Bluetooth devices may not be connected to this unit depending on the Bluetooth version of the device.
- This unit may not work for some Bluetooth devices.
- Connecting conditions may vary depending on your environment.
- Some Bluetooth devices are disconnected when this unit is turned off.
- The Bluetooth devices cannot be used while using Apple CarPlay.
- The Bluetooth currently connected with other device is disconnected when an iPhone compatible with Apple CarPlay is connected.

About the smartphone/cell-phone and Bluetooth audio player

This unit conforms to the following Bluetooth specifications:

Version

- Bluetooth Ver. 5.2

Profiles

- Smartphone/cell-phone:
 - HFP (V1.7) (Hands Free Profile)
 - SPP (Serial Port Profile)
 - PBAP (Phonebook Access Profile)
- Audio player:
 - A2DP (Advanced Audio Distribution Profile)
 - AVRCP (V1.6) (Audio/Video Remote Control Profile)

Sound codec

- LDAC, SBC, AAC

NOTE

- The units supporting the Bluetooth function have been certified for conformity with the Bluetooth Standard according to the procedure prescribed by Bluetooth SIG.
- However, it may be impossible for such units to communicate with your smartphone/cell-phone depending on its type.

Register the Bluetooth device

It is necessary to register the Bluetooth audio player or smartphone/cell-phone in this unit before using the Bluetooth function. You can register up to 10 Bluetooth devices.

NOTE

- Up to 10 Bluetooth devices can be registered. If an attempt is made to register the 11th Bluetooth device, the Bluetooth device connected on the earliest date will be deleted to register the 11th one.
- This unit is compatible with the Apple Easy Pairing function. When an iPhone connected via USB terminal previously is connected again, an authentication dialog appears. Performing operation for authentication on this unit, or iPhone registers the smartphone as a Bluetooth device.

1 Press the  HOME button.
HOME screen appears.

2 Touch .

3 Touch [SETUP].
SETUP Menu screen appears.

4 Touch [Connection & AV].

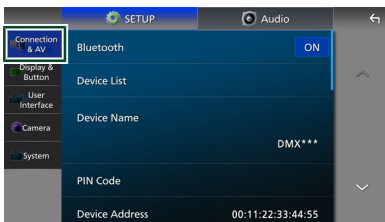

5 Touch [Device List].

6 Touch .

Bluetooth pairing waiting dialog appears.

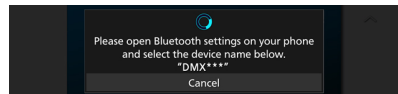

NOTE

- If an Apple CarPlay device is currently connected, the Apple CarPlay device will be disconnected.
- When neither Apple CarPlay, Android Auto, nor a Bluetooth Hands-Free phone is connected, pressing and holding the [VOICE] button displays Bluetooth pairing waiting dialog.

7 Search for the unit ("DMX9724XDS") from your smartphone/cell-phone.

Complete steps **7** to **9** within 30 seconds.

8 Operate your smartphone/cell-phone according to the displayed messages.

- **Confirm the request both on the smartphone/cell-phone.**

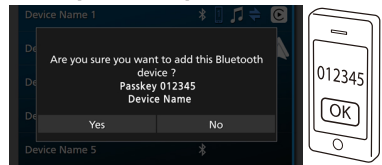

- **Input the PIN Code in your smartphone/cell-phone.**

PIN Code is set to "0000" as the default.

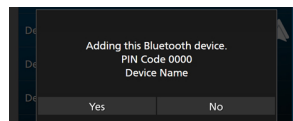

9 Touch [Yes].

When data transmission and connection have completed, the Bluetooth connection icon appears on the screen.

NOTE

- When registering the iPhone that is available for Apple CarPlay wirelessly, a confirmation message appears.
 - [Yes]: Displays the Apple CarPlay screen for wireless connection.
 - [No]: Apple CarPlay is not connected. When using Apple CarPlay, select the iPhone to be used as the [Apple CarPlay] source. See **Switch the connected device (P.46)**.
- The device name selected on step 7 can be changed. See **Change the device name (P.48)**.





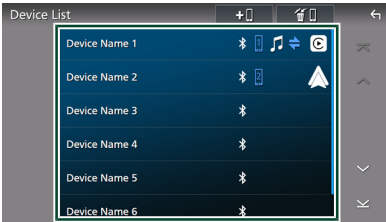

Switch the connected device

If two or more Bluetooth devices have been registered, select the device to be used.

- 1 Touch [Device List] in the Connection & AV setting menu.
- 2 Touch the name of the device you want to connect.



NOTE

- If the icon is lighted, it means that the unit will use that device.
- You can confirm the connection status of Bluetooth, Apple CarPlay or Android Auto as follows.
 - Bluetooth: If the device compatible with Bluetooth is paired,  (Blue),  (White) or  (Blue) is lighted.
 - Apple CarPlay: If the device compatible with Apple CarPlay is connected, the device name (Blue) and  (White) are lighted.
 - Android Auto: If the device compatible with Android Auto is connected, the device name (Blue) and  (White) are lighted.
- Even if the device is compatible with Apple CarPlay or Android Auto, icons are not displayed when;
 - Apple CarPlay is deactivated on the connected device side.
 - The connected device only supports wired Android Auto.
- If you select a device name to which the Apple CarPlay or Android Auto is connected, it will be disconnected.
- You can quickly display the Device List screen by touching  (Device List) in the popup menu. (P.15)

To switch the connected device to a Bluetooth device

- 1 Touch [Bluetooth] on the Device List screen.
Bluetooth device list appears.
- 2 Touch the name of the Bluetooth device you want to connect.

NOTE

- In the following cases, a confirmation message for disconnection appears. Touch [Yes] and follow to next step 2.
 - Select any device when Apple CarPlay is connected.
 - Select the connected device when Android Auto is connected.

3 Set each profile as follows.

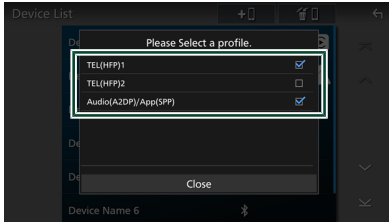

■ [TEL (HFP) 1], [TEL (HFP) 2]

Select when the device is connected with the unit as Hands-Free phone 1 or 2.

■ [Audio (A2DP)/App (SPP)]

Select to use as an audio player or to interwork with an application installed in a smartphone.

4 Touch [Close].

To delete the registered device

You can delete the device that is registered as Bluetooth source or Apple CarPlay source. When you delete a Bluetooth device which supports Android Auto, the device is also deleted from the Android Auto device list.

1 Touch on the Device List screen.

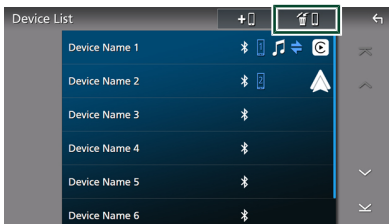

2 Touch the device name to check.

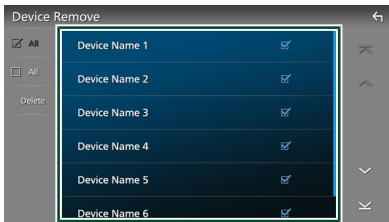

■ All

Selects all Bluetooth devices.

■ All

Clears all check marks.

NOTE

- You cannot select a device currently connected.
- When you select Android Auto tab,  is not displayed.

3 Touch [Delete].

Confirmation message appears.

4 Touch [Yes].

All the selected device(s) is deleted.

Bluetooth Setup

NOTE

- The Bluetooth Setup is disabled while using Apple CarPlay

1 Press the **HOME** button.
HOME screen appears.

2 Touch **[Settings]**.

3 Touch **[SETUP]**.
SETUP Menu screen appears.

4 Touch **[Connection & AV]**.

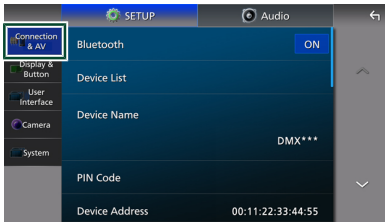

Connection & AV setting menu appears.

5 Touch **[Bluetooth]** and set to **[ON]**.
See the following section for each setting.

- Change the PIN Code (**P.48**)
- Change the device name (**P.48**)
- Change the settings for Hands-Free function, see **Hands-Free Setup (P.56)**.

NOTE

- For the other setting items on this screen, see **Connection & AV Setup (P.64)**.

[Change] Change the device name

1 Touch **[Device Name]** in the **Connection & AV** setting menu.
Change Device Name screen appears.

2 Touch and hold **[BS]**.

3 Input the device name.

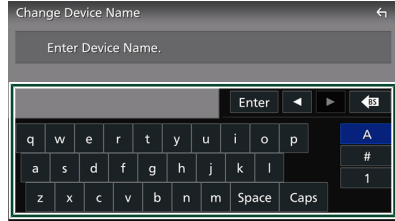

4 Touch **[Enter]**.

[Change] Change the PIN Code

1 Touch **[PIN Code]** in the **Connection & AV** setting menu.
Change PIN Code screen appears.

2 Touch and hold **[BS]**.

3 Input the PIN Code.

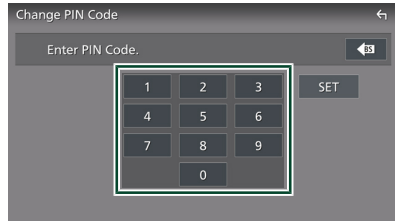

4 Touch **[SET]**.

Playing the Bluetooth Audio Device

Most function can be controlled from the source control screen.

To select Bluetooth source, touch [Bluetooth Audio] icon on the source selection screen.

(P.16)

NOTE

- The Bluetooth audio source is disabled while using Apple CarPlay.
- The Bluetooth audio source is disabled when the device set as Audio(A2DP)/App(SPP) is using Android Auto.

Bluetooth basic operation

Control screen



1 Operation keys *

- **Q** : Searches for a file. See **File search** (P.50).
- **⏮⏪⏩⏭** : Searches for the previous/next content.
Touch and hold to fast forward or fast backward. (It will be cancelled automatically after about 50 seconds.)
- **▶||** : Plays or pauses.
- **📊** : Displays the Graphic Equalizer screen. (P.73)
- **🔄** : Repeats the current track/folder. Each time you touch the key, repeat modes are switched in the following sequence:
File repeat (🔄), Folder repeat (🔄), All songs repeat (🔄 ALL), Repeat off (🔄)

- **🔀** : Randomly plays all tracks in the current folder. Each time you touch the key, random modes are switched in the following sequence:

Folder random (🔀), All random (🔀 ALL), Random off (🔀)

2 Information display *

- Displays the name of track information.
- Connected device name.

3 Play mode indicator/Playing time

▶, ||: Current play mode indicator
Meanings of individual icons are as follows:
▶ (play), ▶▶ (fast forward), ◀◀ (fast backward), || (pause), ■ (stop).

4 KENWOOD Music Mix

Bluetooth audio devices can be switched easily to play music. See **KENWOOD Music Mix** (P.50).

5 ⚙️

Displays the Connection & AV setting menu. (P.48)

6 CODEC

When an LDAC-compatible device is connected, "LDAC" is displayed.

* These items appear only when the audio player which supports AVRCP profile is connected.

NOTE

- The operation keys, indications and information displayed on the screen differ depending on the connected device.
- If the operation keys do not appear, operate from the player.
- Depending on your smartphone/cell-phone or audio player, sound may be heard and controlled but text information may not appear.
- If the volume is too low, raise it on your smartphone/cell-phone or audio player.
- It is recommended that you change the playback quality from "priority on sound quality" to "priority on stable connection" in the settings of your LDAC-compatible device so that the intermittent sound problem is less likely to occur.

Bluetooth Control





KENWOOD Music Mix

Up to 5 Bluetooth audio device can be connected and switched easily to play music.



1 Touch .

A list of registered devices is displayed.

2 Touch of device name you want to connect.

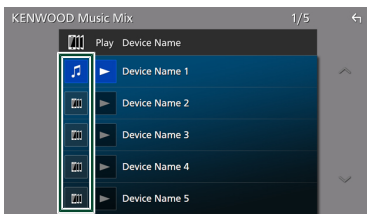
- Touching  displays the Device List screen. (P.45)
- Touching  on the left of the connected device ( ) disconnects this device.





-  : Device used normally.
-  : Device used for KENWOOD Music Mix.

3 Touch (White/dark blue background) on the left of the name of the device to be played.

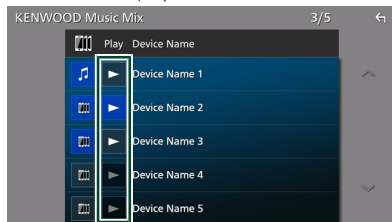
The background changes from dark to light blue and starts playback.



-  (Gray) : Not connected.
-  (White/dark blue background) : Connected.
-  (White/light blue background) : During playback.

4 Touch .

NOTE

- If a connected Bluetooth audio device is operated to play music, connections are switched.
- When a Bluetooth source is switched to another one, its settings are deleted and the connection is restored to the connection before source switching.
- You cannot select an Android smartphone connected as an Android Auto device.

File search

1 Touch Q.

2 Touch the desired file or folder.

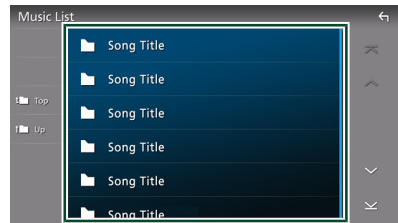

When you touch a folder its contents are displayed.

3 Touch the desired item in the content list. Playback starts.

NOTE

- For operations in the list screen, see **List screen (P.18)**.

Using the Hands-Free Unit

You can use the telephone function by connecting the Bluetooth telephone to this unit.

NOTE

- If you use the Hands-Free function frequently, move the TEL short-cut key (icon) to the Home screen. **(P.16)**
- While using the Bluetooth Hands-Free function, Apple CarPlay or Android Auto is not available.
- While Apple CarPlay or Android Auto is connected, the Bluetooth Hands-Free function and two Bluetooth devices connections cannot be used. Only the Apple CarPlay or Android Auto Hands-Free function can be used.

Make a call

- 1 Press the **HOME** button.
HOME screen appears.
- 2 Touch .
- 3 Touch [TEL].

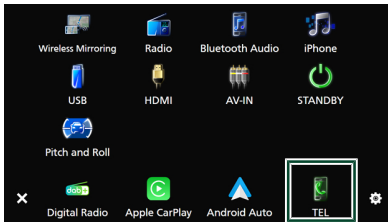





Hands-Free screen appears.

NOTE

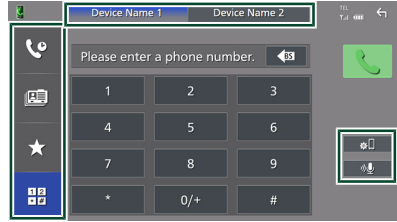
- If your smartphone/cell-phone supports PBAP, you can display the phonebook and call lists onto the touch panel screen when the smartphone/cell-phone is connected.
 - Phonebook: up to 1000 entries
 - Up to 50 entries including dialed calls, received calls, and missed calls



4 Select a dialing method.



- : Call using call records
- : Call using the phonebook
- : Call using the preset number
- : Call by entering a phone number

Select the smartphone/cell-phone to use

When you connect two smartphones/cell-phones

- 1 Touch   to select the phone you want to use.

Bluetooth Setup

- 1 Touch .
Connection & AV setting menu appears. **(P.48)**

Voice Recognition

- 1 Touch . **(P.53)**

NOTE

- Status icons such as battery and antenna icons may differ from those displayed on the smartphone/cell-phone.
- Setting the smartphone/cell-phone in the private mode can disable the Hands-Free function.

Call using call records

- 1 Touch .

Bluetooth Control

2 Select the phone number from the list.

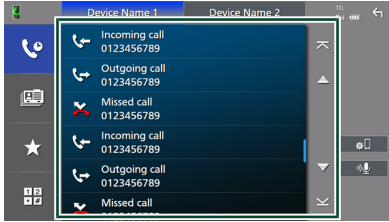

5 Select the phone number from the list.

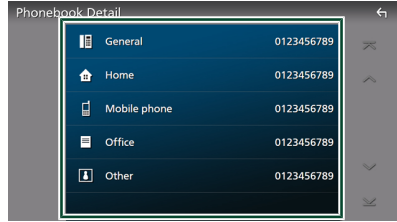

Call using the phonebook

1 Touch .

2 Touch .

3 Select the initial.

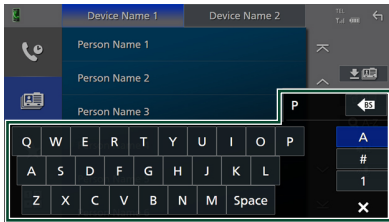

- Characters with no corresponding name will not appear.
- A first character with an accent character such as “ü” can be searched for with a non-accent character “u”. A character with an accent character in a sentence cannot be searched for.

4 Select the person you want to call from the list.

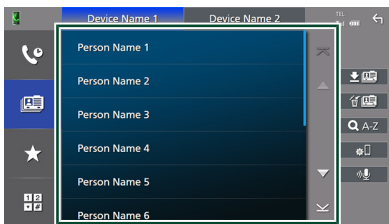

NOTE

- You can sort the phone numbers in the list by last name or first name. For details, see **Hands-Free Setup (P.56)**.
- When Russian is selected in “Language Select” (P.69), you can switch between English keyboard and Russian keyboard.
- When Hebrew is selected in “Language Select” (P.69), you can switch between English keyboard and Hebrew keyboard.
- You can search with 3 initial letters on the English keyboard and 1 initial letter on the Russian / Hebrew keyboard.

Call using the preset number

1 Touch .

2 Touch the name or phone number.



Call by entering a phone number

1 Touch .

2 Enter a phone number with number keys.

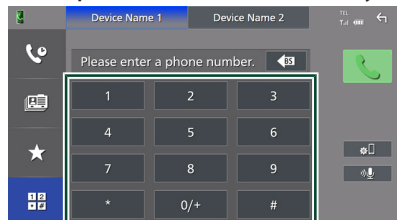

3 Touch .

Voice Recognition

You can access the voice recognition function of the smartphone/cell-phone connected to this unit. You can search the smartphone/cell-phone phonebook by voice. (The functionality depends on the smartphone/cell-phone.)

1 Press the [VOICE] button.

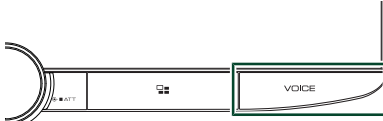

Voice Recognition screen appears.

2 Start speaking.

NOTE

- You can use the voice recognition function by touching  on the Hands-Free screen.
- You can use the voice recognition function for the connected smartphone/cell-phone if you selected [TEL (HFP) 1] or [TEL (HFP) 2] for HFP when registered.

Receive a call

1 Touch to answer a phone call or to reject an incoming call.

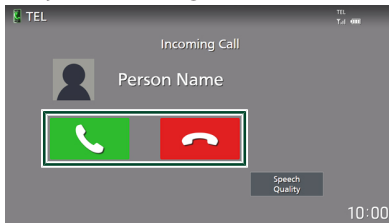

NOTE

- When shifting the gear to the reverse (R) position and monitoring the picture from the rear view camera, this screen does not appear even if a call comes in.
- The portrait registered in the phonebook is displayed while making/receiving calls and during a call.
- If you edit the phonebook on the connected device side after downloading the phonebook, the portrait may not be displayed depending on the edited content. It is recommended that you download the phonebook whenever you edit it.
- The image quality of a displayed portrait may depend on a connected device.

To end call

1 While talking, touch .

Operations during a call

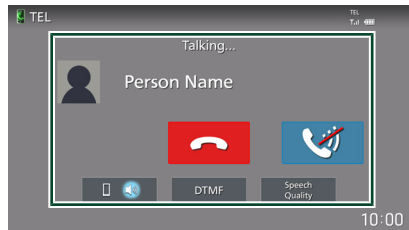

● Adjust call sound quality.

1 Touch [Speech Quality].

2 Touch ◀ or ▶ to adjust each parameter.

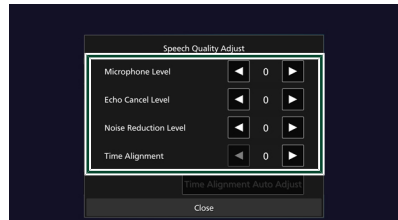

■ [Microphone Level]

Adjust the level of microphone gain. Default is "0".

■ [Echo Cancel Level]

Adjust the level of echo cancellation. Default is "0".

Bluetooth Control

■ [Noise Reduction Level]

Reduce the noise generated in the surrounding environment without changing the microphone volume. Use this function when the voice of caller is not clear. Default is "0".

■ [Time Alignment]

Application Version: 1.3.0006.3200 or later

If an echo generates on the other side of a Hands-Free call (echo cancellation does not work), adjust the sound delay time.

When the [Fiber Optic Output] is set to 48 kHz or 96 kHz, the default is "20".

When the [Fiber Optic Output] is set to OFF, the default is "0".

Application Version: 1.2.0006.3200 or earlier

If the delay in the digital sound output is disrupting the Echo Canceling of hands-free sound, adjust the sound delay time. Default is "20".

This can be adjusted when the digital sound output settings are on.

● Adjust the receiver volume

- 1 Turn the volume knob clockwise to increase, and counter-clockwise to decrease.



● Mute your voice

Touch to mute or not to mute your voice.

● Output the dial tone

Touch [DTMF] to display the tone input screen. You can send tones by touching desired keys on the screen.

● Switching between speaking voice output destinations

Touching / each time switches speaking voice output destinations between the smartphone/cell-phone and the speaker.

● Call-waiting

When you receive a new call while talking on the phone, you can answer the newly received call by touching . The current call is put on hold.

Each time you touch the caller will change to the other one.

When you touch the current call will end to be switched to the call waiting on hold.

■ Phone number preset

You can register frequently used phone numbers in this unit.

- 1 Touch .

- 2 Touch [Edit].



- 3 Select where to preset.

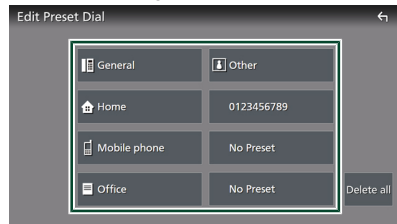

■ [Delete all]

To delete all preset numbers, touch [Delete all] and then touch [Yes] on the confirmation screen.

- 4 Select how to preset.

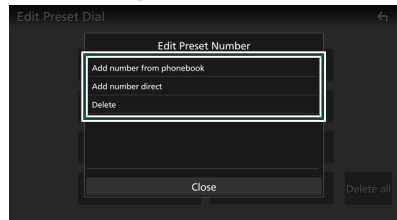

■ [Add number from phonebook]

Select the number to preset from the phonebook.

■ [Add number direct]

Enter the telephone number directly and touch [SET].

■ [Delete]

To delete a preset number, touch [Delete] and then touch [OK] on the confirmation screen.

■ Phonebook transfer

You can transfer phonebook data from your Bluetooth smartphone using PBAP.

1 Touch .

2 Touch .



Phonebook data transfer starts.

NOTE

- If the Phonebook contains more than 1000 entries, only 1000 entries are transferred. The 1001st and later entries are not transferred.
- If no Phonebook has been downloaded, touching [Download Phonebook Now] will start downloading the Phonebook.
- The portrait registered in the phonebook is displayed while making/receiving calls and during a call.

If you edit the phonebook on the connected device side after downloading the phonebook, the portrait may not be displayed depending on the edited content. It is recommended that you download the phonebook whenever you edit it.

Phonebook deletion

1 Touch .

2 Touch the name to check.

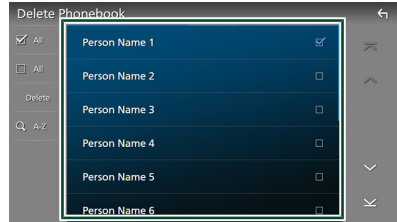

■ All

Checks all boxes.

■ All

Clears all check marks.

3 Touch [Delete].

Confirmation message appears.

4 Touch [Yes].

Hands-Free Setup

You can make various settings for the Hands-Free function.

1 Press the  HOME button.

HOME screen appears.

2 Touch .

3 Touch [SETUP].

SETUP Menu screen appears.

4 Touch [Connection & AV].

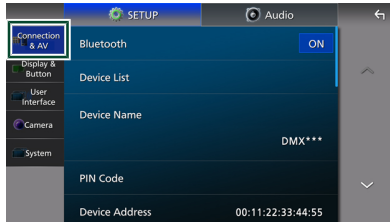

Connection & AV setting menu appears.

5 Touch [TEL SETUP].

TEL SETUP screen appears.

6 Set each function as follows.

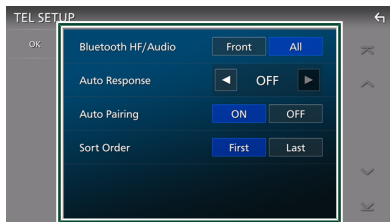

■ [Bluetooth HF/Audio]

Select the speakers to output the sound from the smartphone/cell-phone (such as phone call voice and ringing tone) and Bluetooth audio player.

- [Front]: Outputs sound from the front speakers.
- [All] (Default): Outputs sound from all speakers.

■ [Auto Response]*

Set the automatic response time to pick-up an incoming call.

- [OFF] (Default): Turns off the Automatic response function.

- [1]/[5]/[10]/[15]/[20]/[25]/[30]: Sets the ringing time (second).

* Either the auto response time set on this unit or the time set on the smartphone/cell-phone, whichever is shorter takes effect.

■ [Auto Pairing]

When set to "ON", the Apple Auto Pairing function is turned on to automatically register the iPhone connected to this unit.

- [ON] (Default): Turns on the Apple Auto Pairing function.
- [OFF]: Turns off the Apple Auto Pairing function.

■ [Sort Order]

Set how to sort the data in the smartphone/cell-phone phonebook.

- [First] (Default): Sorts data by the first name.
- [Last]: Sorts data by the last name.

7 Touch [OK].

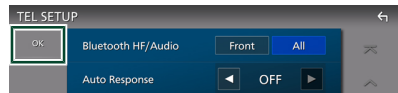

Other External Components

View Camera

NOTE

- To connect a camera, see **Connecting the camera (P.97)**.
- To use a rear view camera, a REVERSE lead connection is required. **(P.93)**
- If [Rear Camera Interruption] is active the camera screen is displayed when you shift the gear to the reverse (R) position.
- The camera whose view was displayed last is kept and the same camera view will be displayed the next time. If its assignment setting is changed, the rear camera view is displayed.
- Rear/front camera interruption screen is not kept as the camera screen which will be displayed the next time.

Display the camera screen

- Press the [MENU/ATT] button.
Pop up menu appears.
- Touch [Camera].



View camera screen appears.

Adjust each item as follows.

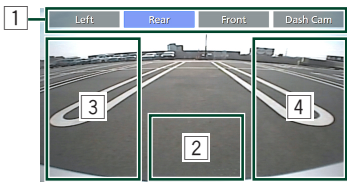

1 Camera Switching Keys *1

Touch to switch the view camera. It is necessary to set "Camera Assignment Settings" beforehand except "Rear". See **To set up the camera assignment settings (P.58)**.

2 Camera off

Touch to exit the camera screen.

3 Switching the Guideline *2

Touching each time turns on or off the guideline.

4 Switching the Angle *2

Touching each time changes camera angles.

- *1 When two or more cameras of rear, front, dashboard, left, and right are connected with this unit.
- *2 Only when the rear camera screen is displayed and CMOS-3xx series is connected with this unit as the rear camera.

Camera Setup

- Press the **HOME** button.
HOME screen appears.
- Touch **Settings**.
- Touch [SETUP].
SETUP Menu screen appears.
- Touch [Camera].
Camera setting menu appears.
- Set each item as follows.

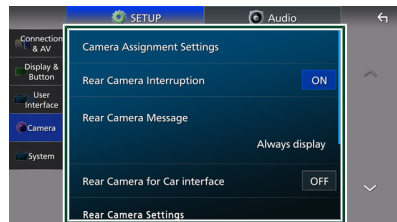

[Camera Assignment Settings]

Set up the camera assignment. See **To set up the camera assignment settings (P.58)**.

[Rear Camera Interruption]

- [ON] (Default): Displays the picture from the rear view camera when you shift the gear to the reverse (R) position.
- [OFF]: Select this when no camera is connected.

[Rear Camera Message] *1

- [Always display] (Default): Always displays the caution message on the rear camera interruption screen.

Other External Components

- [Clear after 5 seconds]: Displays the caution message for about 5 seconds on the rear camera interruption screen.

■ [Rear Camera for Car interface]

- [ON]: Select when you connected an external system unit. Neither keys nor titles are displayed.
- [OFF] (Default): Select when you connected a rear camera.

■ [Rear Camera Settings] *2

Adjusts the CMOS-3xx series with ID 1 ("Rear Camera") set. For details, see the instruction manual of your camera.

■ [Parking Guidelines]

You can display parking guidelines to enable easier parking when you shift the gear to the reverse (R) position. Default is "ON".

■ [Guidelines SETUP]

If you select [ON] for [Parking Guidelines], you can adjust the parking guidelines. See **To adjust the parking guidelines (P.59)**.

■ [Front Camera Settings] *3

Adjusts the CMOS-3xx series with ID 2 ("Front Camera") set. For details, see the instruction manual of your camera.

■ [Front Camera Interruption] *4

- [10 sec]/[15 sec] (Default)/[20 sec]: The front camera screen is displayed when return the gear from the reverse (R) position.
- [OFF]: Cancel.

*1 To use the function, it is necessary to set [Rear Camera Interruption] to [ON].

*2 When CMOS-3xx series is connected with this unit.

*3 To use the function, it is necessary to connect CMOS-3xx series and to set [Camera Assignment Settings] to [Front]. **(P.58)**

*4 To use the function, it is necessary to set [Rear Camera Interruption] to [ON], to set [Rear Camera for Car interface] to [OFF], and to set [Camera Assignment Settings] to [Front]. **(P.58)**

■ To set up the camera assignment settings

1 Touch [Camera Assignment Settings] in the Camera setting menu. **(P.57)**

2 Select the item to set up.

■ [REAR VIEW CAMERA]

The rear camera is always connected to the rear view camera input terminals. This setting cannot be changed.

■ [FRONT VIEW CAMERA / DASH CAM]

Set the camera assignment from view camera connected to Front view camera/Dashboard camera input terminal.

■ [3rd VIEW CAMERA]

Set the camera assignment from view camera connected to 3rd view camera input terminal.

■ [VIDEO IN]

Set the camera assignment from view camera connected to Video input terminal.

3 Select the view camera to set up.

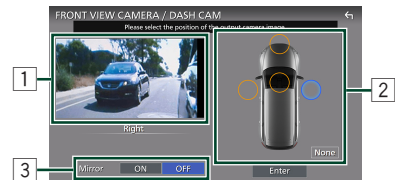

4 Touch [Enter].

1 Picture from view camera

Displays the picture from the view camera connected to the input terminal to be set. **(P.97)**

2 Camera Position

Assign each position to the view camera connected to the selected input terminal. Front/Left/Right/Dashboard Camera/[None]

3 Mirroring setting *1

Switch the mirroring setting. [ON]/[OFF] (Default)

*1 The [FRONT VIEW CAMERA / DASH CAM] and [3rd VIEW CAMERA] setting screens only.

NOTE

- The screen shot above is for the [FRONT VIEW CAMERA / DASH CAM] setting screen. It may be different from the ones for [3rd VIEW CAMERA] and [VIDEO IN].
- The Dashboard Camera can be selected when it is connected. **(P.97)**

NOTE

- Touch [Initialise] and then touch [Yes] to set all the  marks to their initial default position.

To adjust the parking guidelines

NOTE

- Install the rear view camera in the appropriate position according to the instruction manual supplied with the rear view camera.
- When adjusting the parking guidelines, make sure to apply the parking brake to prevent the car from moving.

- 1 Touch [Parking Guidelines] in the Camera setting menu and set to [ON]. (P.57)**
- 2 Touch [Guidelines SETUP] in the Camera setting menu.**
- 3 Adjust the parking guidelines by selecting the  mark.**

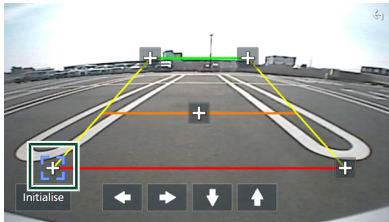

- 4 Adjusting the position of the selected mark.**

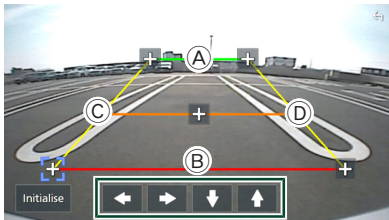

Make sure that lines (A) and (B) are horizontally parallel, and that lines (C) and (D) are of the same length.

Use Dashboard Camera

A Dashboard Camera, DRV-N520 (optional accessory), connected to this unit lets you play video-recorded data and so on. For details, see the instruction manual of the Dashboard Camera DRV-N520 (optional accessory).

NOTE

- To connect a dashboard camera, see **Connecting the camera (P.97)**.
- To use the dashboard camera function, it is necessary to set "Camera Assignment Settings" to "Dashboard Camera". **(P.58)**

Display the dashboard camera screen

- 1 Press the [MENU/ATT] button. Popup menu appears.
- 2 Touch [Camera].

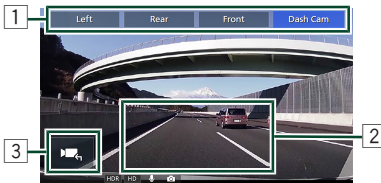

1 Camera Switching Keys

Touch to switch the view camera. It is necessary to set "Camera Assignment Settings" beforehand except "Rear". See **To set up the camera assignment settings (P.58)**.

2 Camera off

Touch to exit the camera screen.

3 Key display

Touch to display the dashboard camera control keys.

External audio/video players (AV-IN)

- 1 Connect an external component to the AV Audio input and the Video input terminal. **(P.95)**
- 2 Select [AV-IN] as the source. **(P.16)**
- 3 Turn on the connected component and start playing the source.

NOTE

- To select the AV-IN source, it is necessary to set "VIDEO IN" to "None" in Camera Assignment Settings. **(P.58)**

HDMI source

- 1 Connect your smartphone to the HDMI input terminal. (P.95)**
Use HDMI cable KCA-HD200 (optional accessory).
- 2 Select [HDMI] as the source. (P.16)**
- 3 Start an application or playback on your smartphone.**

Vehicle Status

Pitch and Roll

Displays the vehicle's angle of pitch, angle of roll, elevation, latitude and longitude, and bearing (compass).

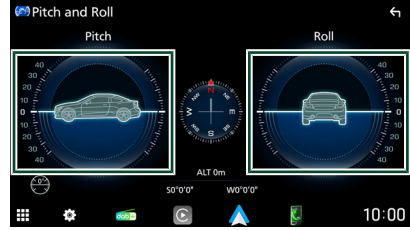
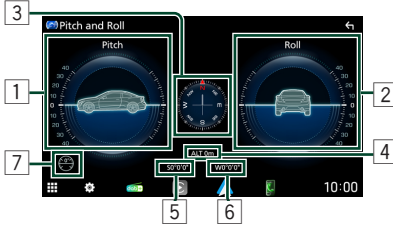

Tap the image of the vehicle on the screen to change the image.

- There are 6 vehicle images. (sports car / station wagon / truck / sedan / box car / SUV)

1 Pitch display

Displays the image of the angle of pitch.

2 Roll display

Displays the image of the angle of roll.

3 Compass display

Displays the direction the vehicle is facing. *1

4 Elevation display

Displays the vehicle's elevation. *1

5 Latitude display

Displays the vehicle's latitude. *1

6 Longitude display

Displays the vehicle's longitude. *1

7 Pitch and Roll Reset button

Resets the pitch and roll angle to 0.

*1 Displays the value obtained from the GPS.

Switching vehicle image

You can change the image displayed for the vehicle.

Setup

1 Press the **HOME** button.
HOME screen appears.

2 Touch **Settings**.

3 Touch **[SETUP]**.

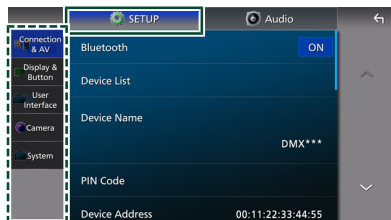

See the following section for each setting.

- Set up connection and AV (**P.64**)
- Set up display and button (**P.66**)
- Set up the user interface (**P.68**)
- Set up camera (**P.57**)
- Set up systems (**P.69**)

■ [Aspect]

Select a screen mode.

- **“Full”**: Changes the aspect ratio of video and displays video fully on the screen.
- **“Normal”**: Displays video at the ratio of 4:3.
- **“Auto”**: USB device: Displays video fully (vertically or horizontally) with no ratio change.

NOTE

- Settings to adjust vary depending on the current source.

Monitor Screen Setup

You can adjust the image quality of video, menu screen, etc.

1 Press the **[MENU/ATT]** button.
Pop-up menu appears.

2 Touch **[Screen Adjustment]**.



Screen Adjustment screen appears.

3 Adjust each setting as follows.

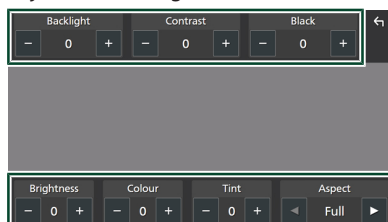

■ [Backlight] / [Contrast] / [Black] / [Brightness] / [Colour] / [Tint]

Adjust each setting.

Connection & AV Setup

You can set connection and AV parameters.

- 1 Press the **HOME** button.
HOME screen appears.
- 2 Touch **⚙️**.
- 3 Touch **[SETUP]**.
SETUP Menu screen appears.
- 4 Touch **[Connection & AV]**.
Connection & AV setting menu appears.
- 5 Set each parameter as follows.

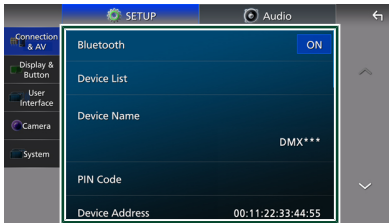

■ [Bluetooth]

Turns the Bluetooth function on or off.

■ [Device List]

Select the connected device to be used.
(P.46)

■ [Device Name]

If you select [ON] for [Bluetooth], you can change the Bluetooth device name. See **Change the device name (P.48)**.

■ [PIN Code]

If you select [ON] for [Bluetooth], you can change the PIN code.
See **Change the PIN Code (P.48)**.

■ [Device address]

Display the Bluetooth device address.

■ [TEL SETUP]

You can make various settings for the Hands-Free function.
See **Hands-Free Setup (P.56)**.

■ [Wireless Mirroring SSID]

You can change the SSID. See **Change the device name or Wireless Mirroring SSID (P.65)**.

■ [Android Auto Auto Launch]

Select whether to display the Android Auto screen automatically. Default is "ON".

■ [Guidance/Voice Recognition Volume]

Adjust the volume of the guidance and voice recognition in Apple CarPlay or Android Auto mode. Default is "19".

■ [Incoming Call Volume (Ring)]

Adjust the ring tone volume in Apple CarPlay or Android Auto mode. Default is "15".

■ [In Call Volume (Talking)]

Adjust the dial tone volume and the volume during a call in Apple CarPlay or Android Auto mode. Default is "15".

■ [Speech Quality Adjust]

Adjust the speech quality.

- **[Microphone Level]** : Adjust the level of microphone gain. Default is "0".
- **[Echo Cancel Level]** : Adjust the level of echo cancellation. Default is "0".
- **[Noise Reduction Level]** : Reduce the noise generated in the surrounding environment without changing the microphone volume. Use this function when the voice of caller is not clear. Default is "0".
- **[Time Alignment]** :
Application Version: 1.3.0006.3200 or later
If an echo generates on the other side of a Hands-Free call (echo cancellation does not work), adjust the sound delay time. When the [Fiber Optic Output] is set to 48 kHz or 96 kHz, the default is "20". When the [Fiber Optic Output] is set to OFF, the default is "0".
Application Version: 1.2.0006.3200 or earlier
If the delay in the digital sound output is disrupting the Echo Canceling of hands-free sound, adjust the sound delay time. Default is "20".
This can be adjusted when the digital sound output settings are on.
- **[Time Alignment Auto Adjust]** :
Application Version: 1.4.0006.3200 or later
If an echo generates on the other side of a Hands-Free call (echo cancellation does not work), adjust the sound delay time automatically. See **Auto Adjustment for Time Alignment (P.65)**

■ **[iPhone Bluetooth Connection]**
See *Select the method of making connections for outputting sound from the iPhone source (P.32)*.

■ **[Reverse with ATT]**
Select whether to decrease the audio volume automatically when the gear is shifted to the reverse (R) position. Default is "ON".

■ **[Reset Android Auto Wireless Connection]**
Regenerate a Pre-shared Key (PSK) to connect wirelessly with Android Auto. A confirmation dialog will appear because the system needs to restart to regenerate a PSK.

■ **[Built-In Amplifier]**
Select whether to use the built-in power amplifier.
Turning off the built-in amplifier improves the quality of the sound from Preout. "ON" (Default) / "OFF"

Change the device name or Wireless Mirroring SSID

- 1 Press the **HOME** button.
HOME screen appears.
- 2 Touch **Settings**.
- 3 Touch **[SETUP]**.
SETUP Menu screen appears.
- 4 Touch **[Device Name] / [Wireless Mirroring SSID]**.
Change Device Name screen or Change Wireless Mirroring SSID appears.
- 5 **Input the device name or SSID.**

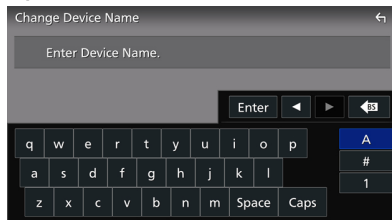

- 6 Touch **[Enter]**.

Auto Adjustment for Time Alignment

Preparation

- Park the vehicle in a safe and quiet location before performing this operation.
- Make sure the microphone is connected and mounted in a location that is in close proximity to the driver before starting the measurement.
- A static sound will be emitted during measurement and gradually increase in volume until the process is completed. You may choose to exit the vehicle and close the doors while the auto adjustment is taking place. (Approx. 2 minutes)
- Note: If you are using an external amplifier with a Time Alignment function, complete the Time Alignment settings before starting the auto adjustment process.
- For best results of the auto adjustment of time alignment process:
 - Perform the measurement in as quiet an environment as possible.
 - Close all windows and doors.
 - Turn off the air conditioner and blower fan.

- 1 Press the **HOME** button.
HOME screen appears.
- 2 Touch **Settings**.
- 3 Touch **[SETUP]**.
SETUP Menu screen appears.
- 4 Touch **[Connection & AV]**.
The Connection & AV settings menu appears.
- 5 Touch **[Speech Quality Adjust]**.
A pop-up window appears.

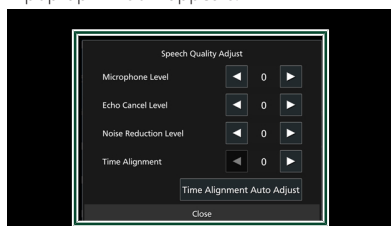

- 6 Touch **[Time Alignment Auto Adjustment]**.
- 7 A confirmation message appears. Touch **[Yes]** twice.
After the second confirmation, the automatic adjustment will begin after 10 seconds.

Setup

- Completed: Automatic adjustment finished successfully.
- Failed: Automatic adjustment did not complete. Please retry in a quieter environment.

8 Touch [Close].

9 Restart the system.

If the adjustment is successful, the Time Alignment values will be applied automatically after restart. The Echo Cancel Level will also be set to "1".

NOTE

- You can cancel the automatic adjustment at any time by touching [Cancel].

Display & Button Setup

- 1 Press the **HOME** button.
HOME screen appears.
- 2 Touch **⚙️**.
- 3 Touch **[SETUP]**.
SETUP Menu screen appears.
- 4 Touch **[Display & Button]**.
Display & Button setting menu appears.
- 5 Set each parameter as follows.

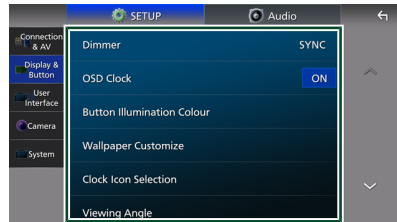

■ [Dimmer]

Select the dimmer mode.

- **[OFF]**: Does not dim the display and buttons.
- **[ON]**: Dims the display and buttons.
- **[SYNC]** (Default): Turns the dimmer function on or off when the vehicle light control switch is turned on or off.

■ [OSD Clock]

Select if you want to display the clock while the screen is off, or while watching video files on USB, etc.

"ON" (Default)/"OFF"

■ [Button Illumination Colour]

You can set the button illumination color.

(P.67)

■ [Wallpaper Customize]

You can change the wallpaper image or color. **(P.67)**

■ [Clock Icon Selection]

Select the Clock Skin for the clock widget on the HOME screen. **(P.68)**

■ [Viewing Angle]

If it is hard to see the image on the screen evenly, adjust the viewing angle. The smaller the (negative) value, the more whitish the image on the screen looks.

"0" (Default)/"-1"/"-2"/"-3"

■ [Screen transition effect]

Select whether to use the screen transition effect when the source control screen is switched to the Home screen.
"ON" (Default)/"OFF"

■ Customizing the button color

You can set the button illumination color.

- 1 Touch [Button Illumination Colour] in the Display & Button setting menu.
- 2 Touch the desired color.

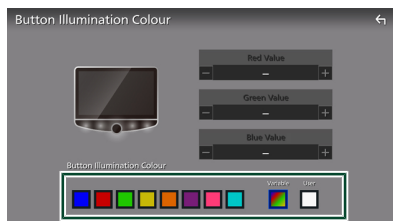

■ [Variable]

You can set the button color to continuously scan through the color spectrum.

■ [User]

You can set the color created with the RGB color mixer.

- 3 Touch .

To register an original color

You can register your original color.

- 1 Touch [User] on the Button Illumination Color screen.
- 2 Use [-] and [+] to adjust each color value.

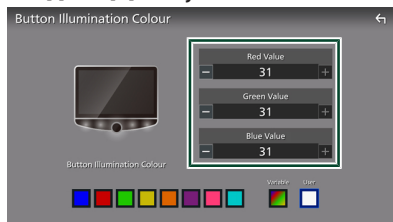

- 3 Touch .

NOTE

- You can create a color based on a preset color. Touch the preset color instead of [User], and adjust the color value.

■ Change the wallpaper image or color

- 1 Touch [Wallpaper Customize] in the Display & Button setting menu.
- 2 Select an image.

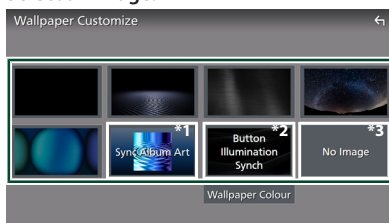

- *1 The album art currently being displayed is used as a wallpaper.
- *2 Select a wallpaper color in advance.
- *3 Select an original image in advance.

To select wallpaper color

- 1 Touch [Wallpaper Colour] on the Wallpaper Customize screen.
- 2 Select a wallpaper color.

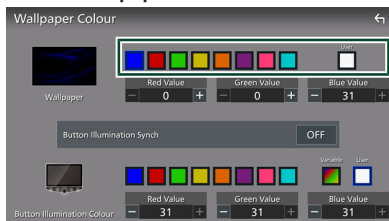

■ [User]

You can set the color created with the RGB color mixer. For how to create an original color, see **To register an original color (P.67)**.

Setup

■ [Button Illumination Synch]

The color you have selected at [Button Illumination Color] can be set. If you adjust the color value with the following RGB color mixer, the adjusted color will be applied to the wallpaper and the button illumination.

For how to set the button illumination color and create an original color, see

Customizing the button color (P.67).

“ON”/“OFF” (default)

- When [Button Illumination Colour] is “Variable”, this option is fixed to OFF.

3 Touch .

To register an original image

With “KENWOOD Portal APP” application installed on your iPhone or Android smartphone, you can upload image files to this unit and set an image as the wallpaper image. See **Importing Image Files (P.21)**.

Change the Clock Skin

1 Touch [Clock Icon Selection] in the Display & Button setting menu.

2 Select an image.



User Interface Setup

You can setup user interface parameters.

1 Press the HOME button.

HOME screen appears.

2 Touch .

3 Touch [SETUP].

SETUP Menu screen appears.

4 Touch [User Interface].

User Interface setting menu appears.

5 Set each parameter as follows.



■ [Source Setup - Remote Control]

Select the sources to be switched with the remote controller. For how to operate the remote controller, see Remote control. (P.82)

■ [Steering Remote Controller]

Sets the desired function in the steering remote controller. (Contact your KENWOOD dealer for details.)

■ [Beep] *1

Turn the key touch tone on or off. Default is “ON”.

■ [Photo Frame Scroll]

Set the Photo Frame Scroll feature. “ON”/“OFF” (default)

■ [Vehicle Adaptor Information] *2

Displays the vehicle information. This function requires a commercial adaptor. Consult your KENWOOD dealer for details.

■ [Beep for Parking distance control] *2

Sets whether to generate a warning tone when the onboard proximity sensor detects a human or object.

Consult your KENWOOD dealer for details.

■ [Parking Distance Display] *2

You can display information about obstacles around the car.

- **[ON]:** Always displays information.
- **[Dyn.] (Default):** Displays information when the sensor detects obstacles.
- **[OFF]:** Cancels.

This function requires a commercial adaptor. Consult your KENWOOD dealer for details.

■ [Parking Distance Position] *2

Select where information about obstacles is displayed on the screen (left or right).

“Left”/“Right” (Default)

This function requires a commercial adaptor. Consult your KENWOOD dealer for details.

■ [Android Auto Screen Size Switching]

Turn the Android Auto Split selection feature on or off.

“ON”/“OFF” (Default)

■ [Driving Position]

Select the driving position (left or right).

“Left” (Default)/“Right”

*1 To use the function, it is necessary to set [Fibre Optic Output] to [OFF], and to set [X'over Network] to [2way].

*2 This setting is available when a commercial adaptor is connected.

System Setup

You can setup system parameters.

1 Press the **HOME** button.
HOME screen appears.

2 Touch **⚙️**.

3 Touch **[SETUP]**.
SETUP Menu screen appears.

4 Touch **[System]**.
System setting menu appears.

5 Set each parameter as follows.

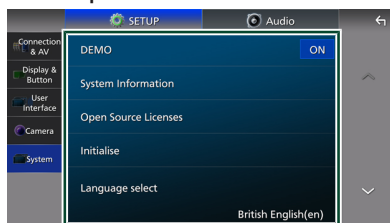

■ [DEMO]

Select the demonstration mode. Default is “ON”.

■ [System Information]

Confirm the system information of this unit. (P.70)

■ [Open Source Licenses]

Display the open source licenses.

■ [Initialise]

Touch [Initialise] and then touch [Yes] to set all the settings to the initial default settings.

- Audio SETUP Memory is not initialized.

■ [Language Select]

Select a language.

■ [Time Format]

■ [Time Zone]

You can set the time. See *Select the time zone and time format (P.14)*.

■ [Security Code Set]

■ [Security Code Cancellation]

■ [Security Code Change]

You can set up a security code. See *Security Code Setup (P.13)*.

Setup

System Information

You can confirm the software version of this unit.

- 1 Touch [System Information] in the System setting menu.
- 2 Verify the software version and model name.

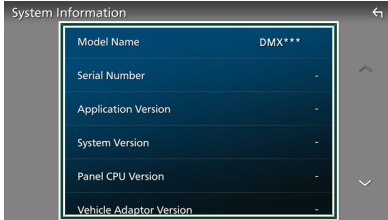

NOTE

- For how to update the software, see the relevant update procedure manual which comes with the software.

Controlling Audio

The [System Configuration] settings must match the configuration of the connected amplifiers and speakers. **(P.13)**

● Using an amplifier with digital inputs

When using an optical digital output, set the output sampling frequency in [Fibre Optic Output] to either 48 kHz or 96 kHz. **(P.13)**

NOTE

- The bit count to 24-bit.
- If the digital output is set to 48 kHz or 96 kHz, the following Audio settings will be disabled.
 - Speaker / X'over
 - EQ / SW Level
 - Position / DTA
 - Fader / Balance
 - Sound Effect
 - Parametric Equalizer
 - Audio Memory
 - 3Way X'over Network
 - EQ settings widget on the HOME screen
 - Beep for User Interface Setup

● Select the appropriate crossover network mode for the speaker system used (2-way or 3-way speaker system)

▲ CAUTION

Connecting 3-way speakers with the 2-way mode selected can break the speakers.

Set [X'over Network] to either 2-way or 3-way. **(P.13)**

For the connection method, see 3-way speaker system setup. **(P.94)**

NOTE

- When the 3-way speaker system is selected, the following functions are disabled.
 - Fiber Optic Output
 - Front focus of Listening Position / DTA
 - Fader for Controlling General Audio
 - Selection of the speakers to output sound from the smartphone/cell-phone of Bluetooth HF/ Audio
 - Beep for User Interface Setup

● Select whether to use the built-in amplifier

Set the [Built-In Amplifier] to either ON or OFF. **(P.13) (P.64)**

Turning off the built-in amplifier improves the quality of the sound from Preout.

Audio Setup

You can adjust various settings such as audio balance or subwoofer level.

1 Press the **HOME** button.
HOME screen appears.

2 Touch **Settings**.

3 Touch [Audio].

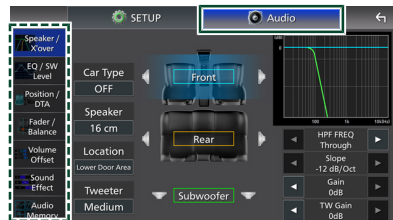

See the following section for each setting.

- Set up Speaker / X'over **(P.72)**
- Controlling EQ / SW Level **(P.73)**
- Set Position / DTA **(P.74)**
- Controlling Fader / Balance **(P.76)**
- Set Volume Offset **(P.77)**
- Set Sound Effect **(P.77)**
- Use Audio Memory **(P.81)**

Speaker / X'over setup

- 1 Press the **HOME** button.
HOME screen appears.
- 2 Touch **Settings**.
- 3 Touch **[Audio]**.
Audio screen appears.
- 4 Touch **[Speaker / X'over]**.
- 5 Select a car type.
You can select the car type and speaker network, etc.
When you select your car type, the Delay Time Alignment is activated automatically (for timing adjustment of sound output for each channel) to have the highest surround effects.

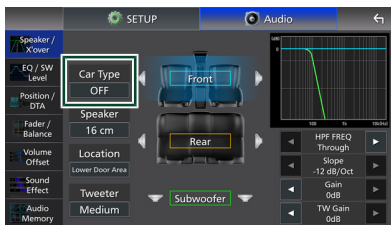

- 6 Touch the speaker (1) you wish to adjust and set each parameter (2) as follows.



■ [Speaker]

You can select a speaker type and its size to get the best sound effects. If no rear speakers or subwoofer are connected, select "None" for each. When the speaker type and size are selected, the speaker crossover network is set automatically.

■ [Location] (Only for Front, Rear)

Select the speaker position you have installed.

■ [Tweeter] (Only for Front)

You can set up the tweeter when you are selecting front speakers.

None, Small, Medium, Large

■ [HPF FREQ] (Only for Front, Rear)

High Pass Filter adjustment.

■ [LPF FREQ] (Only for Subwoofer)

Low Pass Filter adjustment.

■ [Slope]

Set a crossover slope.

■ [Gain]

Adjust the gain of the front speaker, rear speaker, or subwoofer.

■ [TW Gain] (Only for Front)

Adjust the tweeter level.

■ [Phase Inversion] (Only for Subwoofer)

Set the phase of subwoofer output.

Check [Phase Inversion] to shift the phase 180 degrees.

When Speaker network is set to 3-way:

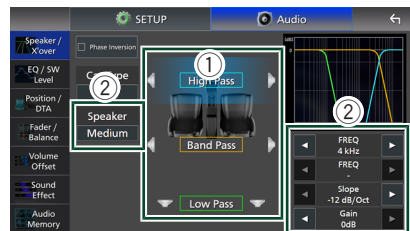

■ [Speaker]

You can select a speaker type and its size to get the best sound effects.

When the speaker type and size are selected, the speaker crossover network is set automatically.

■ [FREQ] (High Pass)

High Pass Filter adjustment. (Only for High Pass)

■ [FREQ] (Low Pass)

Low Pass Filter adjustment. (Only for Low Pass)

■ [HPF FREQ], [LPF FREQ] (Only for Band Pass)

Band Pass Filter adjustment.

■ [Slope]^{*1 *2}

Set a crossover slope.

■ [Gain]

Set the gain of each speaker.

■ [Phase Inversion]

Set the phase of tweeter, mid range, and woofer output.

Check [Phase Inversion] to shift the phase 180 degrees.

- *1 Only when "LPF FREQ"/"HPF FREQ" (Band Pass) is set to a mode other than "Through".
- *2 Only when "FREQ" (Low Pass) is set to a mode other than "Through".

NOTE

- For how to switch to the 3-way speaker system, see [X'over Network] in the System Configuration settings. (P.13)

Equalizer Control

You can adjust equalizer by selecting the optimized setting for each category.

- 1 Press the **HOME** button.
HOME screen appears.
- 2 Touch **Settings**.
- 3 Touch **[Audio]**.
Audio screen appears.
- 4 Touch **[EQ / SW Level]**.
- 5 Touch the screen and set the Graphic Equalizer as desired.

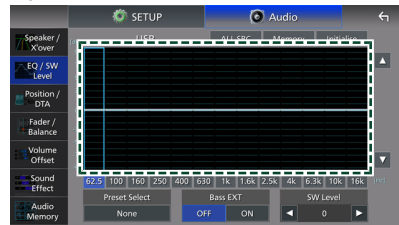

■ Gain level (area in dotted frame)

Adjust the gain level by touching each frequency bar.

You can select a frequency bar and adjust its level by [**▲**], [**▼**].

■ [ALL SRC]

Apply the adjusted equalizer curve to all sources. Touch [ALL SRC] and then touch [OK] on the confirmation screen.

■ [Memory]

Saves the adjusted equalizer curve as "User1" to "User4". (P.74)

■ [Initialise]

Initialize (flatten) the current EQ curve.

■ [Preset Select]

Display the screen for selecting the preset equalizer curve. (P.74)

■ [Bass EXT] (Bass Extend Settings)

When turned on, the frequencies lower than 62.5 Hz is set to the same gain level (62.5 Hz).

■ [SW Level]

Adjust the subwoofer volume. This setting is not available when Subwoofer is set to "None". See **Speaker / X'over setup** (P.72).

Controlling Audio

Recall the EQ curve

- 1 Touch [Preset Select].
- 2 Select an EQ curve.

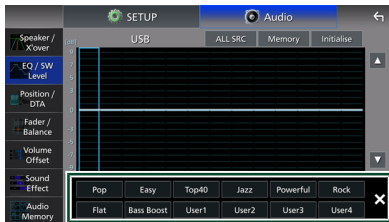

Save the EQ curve

- 1 Adjust the EQ curve.
- 2 Touch [Memory].
- 3 Select where to save.

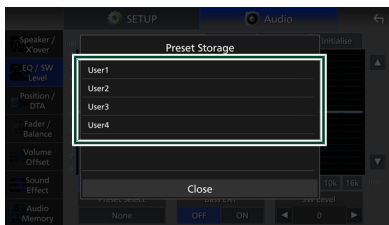

Listening Position / DTA

Listening Position / DTA allows you to improve the sound field depending on the position of the seat you sit.

Listening Position / DTA allows you to set "Listening Position" and "Front Focus". You cannot set both at the same time.

- 1 Press the **HOME** button. HOME screen appears.
- 2 Touch .
- 3 Touch [Audio]. Audio screen appears.
- 4 Touch [Position / DTA].

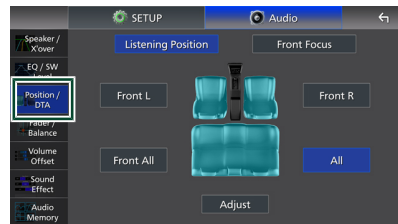

- Set up Listening Position (**P.74**)
- Set up Front Focus (**P.75**)

Listening Position

Adjust the sound delay time so that the sounds from different speakers arrive at the listener sitting on the selected seat at the same time.

- 1 Touch [Listening Position] on the Position / DTA screen.
- 2 Select a listening position from [Front R] (Right front), [Front L] (Left front), [Front All] (All front), and [All].

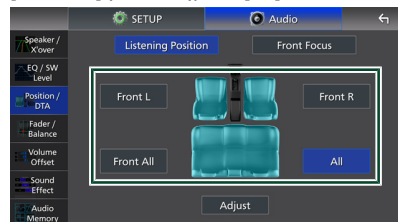

Position DTA control

You can fine-adjust your listening position.

- 1 Touch [Adjust].
- 2 Touch [Delay].
- 3 Touch [◀] or [▶] to adjust the delay time of the selected speaker.



- 4 Touch [Level].
- 5 Touch [◀] or [▶] to adjust the sound level of the selected speaker.

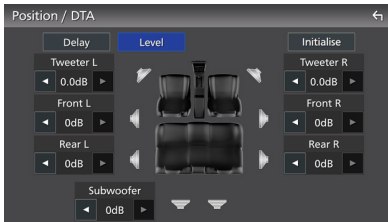

NOTE

- To initialize the Delay and Level settings, touch [Initialise] and [YES] on the confirmation screen.

Front Focus

You can focus the imaginary sound image on the front of the selected seat.

- 1 Touch [Front Focus] in the Position / DTA screen.

- 2 Select a front focus position.

For [Front All] and [All], select Priority L or R depending on which side you want to put the imaginary sound image.

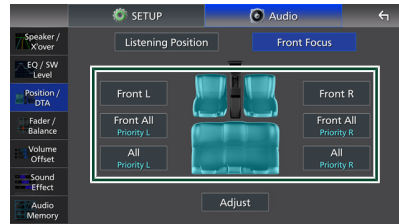

NOTE

- When the 3-way speaker system is selected, front focus feature is disabled.

Front Focus fine adjustment

- 1 Touch [Adjust].
- 2 Touch [Delay].
- 3 Set each parameter as follows.

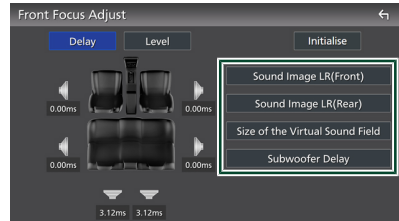

■ [Sound Image LR (Front)]

Focus the sound image on the front of front seats.

■ [Sound Image LR (Rear)]

Focus the sound image on the front of rear seats.

■ [Size of the Virtual Sound Field]

Adjust the size of sound image to meet your taste. If the sound image is shifted from the front, move it back by [Sound Image LR (Front)] or [Sound Image LR (Rear)].

■ [Subwoofer Delay]

Adjust the delay time of subwoofer sound.

- 4 Touch [Level].

Controlling Audio

- 1 Touch [◀] or [▶] to adjust the sound level of the selected speaker.

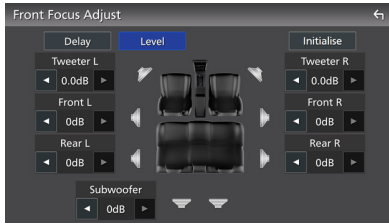

NOTE

- To initialize the Delay and Level settings, touch [Initialise] and [YES] on the confirmation screen.

Fader / Balance

You can adjust the volume balance among the speakers.

- 1 Press the **HOME** button.
HOME screen appears.
- 2 Touch **Settings**.
- 3 Touch [Audio].
Audio screen appears.
- 4 Touch [Fader / Balance].

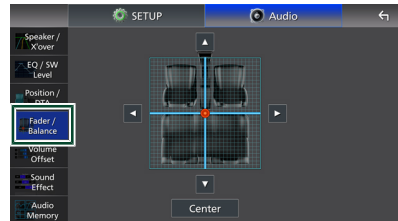

- 5 Touch [◀], [▶], [▲], and [▼] to adjust the volume balance.

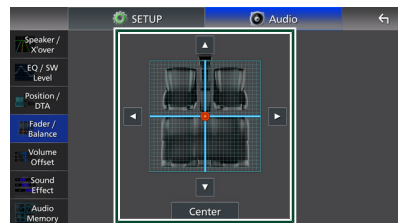

[◀] and [▶] adjust the left and right volume balance.

[▲] and [▼] adjust the front and rear volume balance.

■ [Center]

Clear the adjustment.

NOTE

- When the 3-way speaker system is selected, "Fader" adjustment is disabled.

Volume Offset

Finely adjust the volume of the current source to minimize the difference in volume between different sources.

- 1 Press the **HOME** button.
HOME screen appears.
- 2 Touch **Settings**.
- 3 Touch **[Audio]**.
Audio screen appears.
- 4 Touch **[Volume Offset]**.
- 5 Touch **[+]** or **[-]** to adjust the level.



■ [Initialise]

Returns to the initial settings.
Touch [Initialise] and then touch [YES] on the confirmation screen.

NOTE

- If you have increased the volume first, then reduce the volume using "Volume Offset". Switching the current source to another source suddenly may output extremely loud sound.

Sound Effect

You can set sound effects.

- 1 Press the **HOME** button.
HOME screen appears.
- 2 Touch **Settings**.
- 3 Touch **[Audio]**.
Audio screen appears.
- 4 Touch **[Sound Effect]**.
- 5 Set each parameter as follows.



■ [Bass Boost]

Set the amount of bass boost
"OFF"/"1"/"2"/"3".

■ [Loudness]

Set the amount of boost of low and high tones.
"OFF", "Low", "High"

■ [Drive Equalizer]

Reduces the driving noise by raising the bandwidth.
"OFF", "ON"

■ [Space Enhancer]

Select the feeling of sound space enhancement.
"OFF"/"Small"/"Medium"/"Large".
This setting is not available for the Digital Radio and Radio source.

■ [Supreme]

Turn ON/OFF the Supreme function.
Technology to extrapolate and supplement with proprietary algorithm, the high-frequency range that is cut off when encoding.

■ [Sound Realizer]

Virtually make the sound more realistic using the Digital Signal Processor (DSP) system.
Select the level from "OFF"/"1"/"2"/"3".

Controlling Audio

■ [Stage EQ]

You can adjust the height of speakers virtually to suit your listening position. "OFF"/"Low"/"Middle"/"High".

■ [Parametric EQ]

When set to "ON", you can use the parametric equalizer. For details, see **Parametric Equalizer (P.78)**.

Parametric Equalizer

In addition to the conventional Graphic Equalizer, this unit has a parametric equalizer, which allows you more precise adjustments. By using each equalizer properly, you can calibrate the unit more thoroughly.

Adjustment using this function requires expertise.

When to Use Each Function

- **Parametric Equalizer**
Use this to finely correct or improve the frequency characteristics of the acoustics of the car in order to establish a basis for adjustments.
Practiced ears or a measuring equipment may be required to apprehend the problems of the sound field inside the car.
- **Graphic Equalizer**
Use this to actively create an attractive sound as conventionally.
Everybody can easily get the result through trial and error of intuitive operations.
Even more effective adjustments are possible when the basis is established by using the Parametric Equalizer.

■ About the Parametric Equalizer

This system allows you to freely control the filter, frequency, Q factor (acuteness) and slope gain at 14 points consisting of 9 points common for front/rear/subwoofer, 2 points for front only, 2 points for rear only, and one point for subwoofer only.

NOTE

- Configure the Parametric Equalizer to establish the basis for adjustments before making adjustments using the Graphic Equalizer.
- The changes made using the Parametric Equalizer are not shown on the Graphic Equalizer screen.
- You can check the effects using the Parametric Equalizer ON/OFF key.

About Adjustments

If there are unpleasant peaks, you can slide the peaking filter to the left or right and search the frequencies by ear. Studio engineers use this method to make adjustments quickly and efficiently.

However, in order to identify peaks and dips of a car audio system, you have to capture the pink noise outputted from the speaker using a microphone and analyze it using a real time analyzer (RTA). From the analysis result, identify the peaks and/or dips that need to be corrected and configure the filters to cancel them.

About the Filters of Parametric Equalizer

Filters allow you to remove or extract specific sound through signal processing.

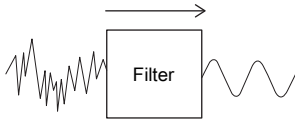

NOTE

- Cutoff frequency is the boundary between the passband and the stopband. The definition of cutoff frequency is a frequency for which the output is -3 dB of the nominal passband value.

● High-Pass Filter

Passes signals with frequencies higher than a certain frequency (f_c : cutoff frequency) and attenuates signals with frequencies lower than the cutoff frequency. Use this to pass only high-frequency signals. Use this in the following cases for example:

- For extracting the frequency band for separate tweeters. By extracting the specific frequency band, level adjustment can be made to the frequency band individually.

- The sound may be muddy when you play back low frequency sound. This occurs when frequencies below the speaker capacity is inputted. To cancel this, use the high-pass filter to cut off the frequencies below the speaker capacity.

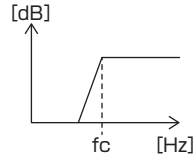

● High-Shelving Filter/Low-Shelving Filter

These filters reduce or increase signals above or below a certain frequency (f_c : cutoff frequency), which create shelves in the frequency spectrums. A high-shelving filter reduces or increases the frequencies above the target frequency and a low-shelving filter reduces or increases the frequencies below the target frequency. The low shelf controls the lower frequencies and the high shelf controls the high frequencies. Use these in the following cases for example:

- When you want to change the volume of the tweeters, for example when they are close to your ears and are sounding too loud.
- When you want to change the subwoofer volume at hand.

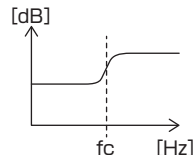

● Peaking Filter

The frequencies in the vicinity of a certain frequency (f_0 : center frequency) are boosted or attenuated. Use this in the following cases for example:

- When you want to control a narrow range of frequencies to correct the frequency abnormality in the car.
- To diminish a chattering noise from the speaker by attenuating the frequency range of the noise.

Controlling Audio

- To adjust of the sound balance of the whole range between the low end and the high end.

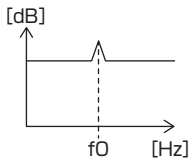

● Low-Pass Filter

Passes signals with frequencies lower than a certain frequency (f_c : cutoff frequency) and attenuates signals with frequencies higher than the cutoff frequency. Use this to pass only low-frequency signals. Use this in the following cases for example:

- For extracting the low frequencies band for a subwoofer.
- For extracting middle/low frequencies when you are using speakers with separate tweeters and you want to output the high frequencies to the tweeters and output the middle/low frequencies to the woofers.
- To cut the high frequencies when they are too loud.

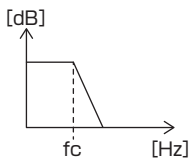

■ Adjust the Parametric Equalizer

Preparation

- Correct the value in "Listening Position" and "Front Focus" before adjusting the parametric equalizer. See *Listening Position / DTA (P.74)*.

- 1 Press the **HOME** button.
HOME screen appears.
- 2 Touch **Settings**.
- 3 Touch **[Audio]**.
- 4 Touch **[Sound Effect]**.
- 5 Set the Parametric EQ to **[ON]** and touch **[Yes]**.

- 6 Touch **[SETUP]**.
Parametric EQ screen appears.
- 7 While auditioning music, move the peaking filter to the left and right to search for unpleasant peaks and suppress them.
- 8 Use pink noise and an analyzer to identify dips, as dips are difficult to find.
Correct steep (10 dB or greater) peaks and dips as these are generally regarded as obstructions to sound quality.
- 9 Set each parameter as follows.

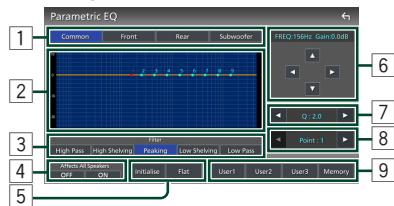

- 10 When you have finished adjustments, save the results as a preset, and check the effects by switching presets or turning the Parametric EQ **[ON]** and **[OFF]**.
- 11 Use the Graphic Equalizer to make final adjustments. (P.77)

1 Speaker

Select the speaker.

- **When Speaker network is set to 2-way:** "Common" / "Front" / "Rear" / "Subwoofer"
- **When Speaker network is set to 3-way:** "Common" / "Tweeter" / "Middle" / "Woofer"

2 EQ points/curve

Displays the EQ point and the curve. Adjust the EQ points by touching.

- **EQ point (red):** The EQ point currently being adjusted.
- **EQ point (blue/yellow):** EQ points that are not currently being adjusted.
- **Curve (orange):** EQ curve of the speaker currently being adjusted.
- **Curve (blue):** Overall EQ curve.

3 Filter

Select the filter.

“High Pass” / “High Shelving” / “Peaking” / “Low Shelving” / “Low Pass”

4 Affects All Speakers**

- **[ON]:** Outputs sound from all speakers.
- **[OFF]:** Outputs sound from the currently selected speaker only.

5 [Initialise] / [Flat]

- **[Initialise]:** Initialize (flatten) the adjustment of all the speakers.
- **[Flat]:** Initialize (flatten) the adjustment of the current speaker.

6 Frequency / Gain

Set the frequency and gain.

[◀] and [▶] adjust the frequency.

[▲] and [▼] adjust the gain.

NOTE

- Touch the EQ point to roughly determine the frequency and gain, then use this key to make fine adjustments.

7 Q / Slope**

Set the Q factor and slope.

8 Point

Select the EQ point to adjust.

9 Preset

- **[User1] / [User2] / [User3]:** Recalls the preset EQ.
- **[Memory]:** Stores the current EQ settings.

*1 Only when the speaker other than “Common” is selected.

*2 When “Peaking” filter is selected, you can adjust the Q factor. When “High Pass” or “Low Pass” filter is selected, you can adjust the slope.

NOTE

- You can adjust the EQ points and curve based on a preset EQ. Recall the preset EQ and touch the preset key again to unselect it before adjustment.

Audio Setup memory

Audio Control settings can be memorized. The memorized settings can be recalled at any time.

1 Press the  HOME button.

HOME screen appears.

2 Touch .**3 Touch [Audio].**

Audio screen appears.

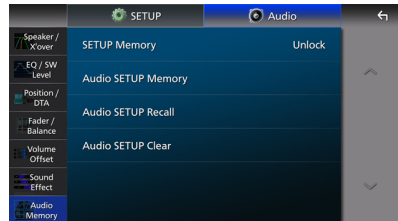
4 Touch [Audio Memory].**■ [SETUP Memory]**

Lock or unlock the Audio SETUP Memory/ Recall/Clear.

■ [Audio SETUP Memory]

Memorize the current audio settings. Fader / Balance, Speaker / X'over, Equalizer (User Preset, SW Level), Position / DTA, Sound Effect (**P.71**)

■ [Audio SETUP Recall]

Recall the memorized audio setting.

■ [Audio SETUP Clear]

Clear the Audio SETUP Memory and the currently memorized audio settings.

Remote control (optional)

This unit can be operated using the remote control KCA-RCDV340 (optional accessory).

▲ CAUTION

- Put the remote control in a place where it will not move during braking or other operations. A dangerous situation could result, if the remote control falls down and gets wedged under the pedals while driving.
- Risk of fire or explosion if the battery is replaced by an incorrect type.
- Ensure to replace only with the same type.
- Risk of fire, explosion or the leakage of flammable liquid or gas if the battery is left in an extremely high temperature surrounding environment and/or subjected extremely low air pressure. The battery pack or batteries shall not be exposed to excessive heat such as sunshine, fire or the like.
- Risk of fire, explosion or the leakage of flammable liquid or gas if the battery is disposed into fire or a hot oven, recharged, shorted, mechanically crushed or cut of the battery.
- If spilled fluid comes in contact with your eyes or on clothing, immediately rinse with water and consult a physician.

Battery Installation

If the remote control operates only over shorter distances or does not operate at all, it is possible that the batteries are depleted. In such instances, replace the both batteries with new ones.

- 1 Insert two "AAA"/"R03"-size batteries with the ⊕ and ⊖ poles aligned properly, following the illustration inside the case.

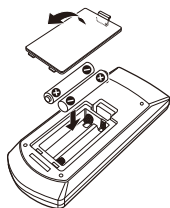

Functions of the Remote control Buttons

Switch the operation mode

The functions operated from the remote control differ depending on the position of the mode switch.

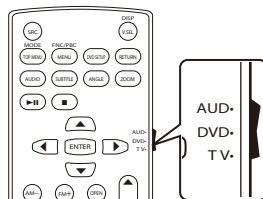

■ AUD mode

Switch to this mode when controlling a selected source or tuner source, etc.

■ DVD mode/TV mode

Not used.

NOTE

- When controlling a player that is not integrated in the unit, select "AUD" mode.

Direct search mode

Using the remote control, you can jump directly to the tuner frequency.

NOTE

- This operation cannot be performed for the USB device and iPhone.

- 1 Press the [DIRECT] button several times until the desired content appears.

The available contents are different depending on the source type.

■ Radio

Frequency value

- 2 Press number buttons to enter a frequency.

- 3 Press the [◀▶] button.

The content corresponding to the number you entered is played.

Basic Operation

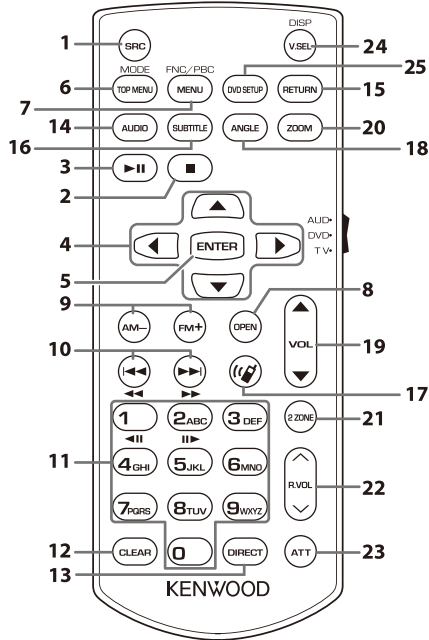

	Key Name	Mode switch	Function
1	SRC	—	Switches to the source to be played. In Hands-Free mode, hangs up the phone.
2	■	—	Not used.
3	▶▶	—	Pauses the track or file, and resumes playing by pressing twice. For the Radio and Digital Radio sources in AUD mode, switches the seek mode.
4	▲/▼/◀▶	—	Not used.
5	ENTER	—	Performs the selected function.
6	TOP MENU	AUD	Screen mode changes each time you press this key during video playback.
7	MENU	AUD	Displays the control screen of current source. (USB)
8	OPEN	—	Not used.
9	AM-/FM+	AUD	Selects the folder to be played. For the Radio sources in AUD mode, selects FM/AM band to be received.
10	◀◀▶▶	—	Selects the track or file to be played. For the Radio and Digital Radio sources in AUD mode, switches to broadcast stations received by the unit.

Remote control (optional)

	Key Name	Mode switch	Function
11	Numeric Keypad	AUD	Allows you to enter the number to search in the direct search mode. For details on the direct search mode, see Direct search mode (P.82) . For the Radio and Digital Radio sources, allows you to enter the preset number. If the preset number is one digit, press the number. If the preset numbers is two digits, press continuously the numbers within 3 seconds. Pressing ◀◀ ▶▶ within 3 seconds allows you to determine the preset number of one digit.
12	CLEAR	–	Not used.
13	DIRECT	–	Switches to the direct search mode. (P.82) .
14	AUDIO	–	Not used.
15	RETURN	–	Not used.
16	SUBTITLE	–	Not used.
17		–	When a call comes in, answers the call.
18	ANGLE	–	Not used.
19	VOL ▲▼	–	Adjusts the volume.
20	ZOOM	–	Not used.
21	2 ZONE	–	Not used.
22	R.VOL ^ v	–	Not used.
23	ATT	–	Lowers the volume by pressing the key once. Restores the previous volume by pressing the key twice.
24	V.SEL/DISP	–	Switches between the Apple CarPlay, Android Auto, Wireless mirroring and AV source screen each time it is pressed.
25	DVD SETUP	–	Not used.

Connection/Installation

This section is for the professional installer. For safety's sake, leave wiring and mounting to professionals. Consult the car audio dealer.

Before Installation

Before installation of this unit, please note the following precautions.

▲ WARNINGS

- If you connect the ignition wire (red) and the battery wire (yellow) to the car chassis (ground), you may cause a short circuit, that in turn may start a fire. Always connect those wires to the power source running through the fuse box.
- Do not cut out the fuse from the ignition wire (red) and the battery wire (yellow). The power supply must be connected to the wires via the fuse.

▲ CAUTION

- Install this unit in the console of your vehicle.
- Do not touch the metal part of this unit during and shortly after the use of the unit. Metal part such as the heat sink and enclosure become hot.

NOTE

- Mounting and wiring this product requires skills and experience. For best safety, leave the mounting and wiring work to professionals.
- Do not install the unit if it becomes an obstacle to driver performance.
- Adjust the panel position not to become an obstacle to driver performance.
- Make sure to ground the unit to a negative 12V DC power supply.
- Do not install the unit in a spot exposed to direct sunlight or excessive heat or humidity. Also avoid places with too much dust or the possibility of water splashing.
- Do not use your own screws. Use only the screws provided. If you use the wrong screws, you could damage the unit.

- If the power is not turned ON ("There is an error in the speaker wiring. Please check the connections." is displayed), the speaker wire may have a short-circuit or touched the chassis of the vehicle and the protection function may have been activated. Therefore, the speaker wire should be checked.
- If your car's ignition does not have an ACC position, connect the ignition wires to a power source that can be turned on and off with the ignition key. If you connect the ignition wire to a power source with a constant voltage supply, such as with battery wires, the battery may be drained.
- If the console has a lid, the lid will not be closed even when the unit is installed correctly.
- If the fuse blows, first make sure the wires are not touching to cause a short circuit, then replace the old fuse with one with the same rating.
- Insulate unconnected wires with vinyl tape or other similar material. To prevent a short circuit, do not remove the caps on the ends of the unconnected wires or the terminals.
- Connect the speaker wires correctly to the terminals to which they correspond. The unit may be damaged or fail to work if you share the ⊖ wires or ground them to any metal part in the car.
- When only two speakers are being connected to the system, connect the connectors either to both the front output terminals or to both the rear output terminals (do not mix front and rear). For example, if you connect the ⊕ connector of the left speaker to a front output terminal, do not connect the ⊖ connector to a rear output terminal.
- After the unit is installed, check whether the brake lamps, blinkers, wipers, etc. on the car are working properly.
- This unit has the cooling fan to decrease the internal temperature. Do not mount the unit in a place where the cooling fan of the unit is blocked. Blocking these openings will inhibit the cooling of the internal temperature and result in malfunction.

Connection/Installation

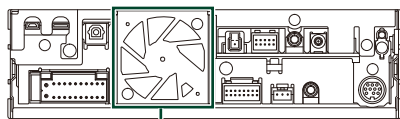

Cooling fan

- Do not press hard on the panel surface when installing the unit to the vehicle. Otherwise scars, damage, or failure may result.
- Reception may drop if there are metal objects near the Bluetooth/Wi-Fi antenna.

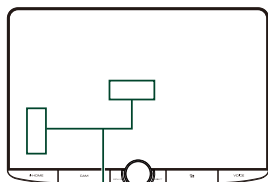

Bluetooth/Wi-Fi antenna unit

● Forward and Lateral Fields of Vision

- To determine driver's forward and lateral fields of vision under normal conditions, place a pole (directly visible from the front or visible through the car rear-view mirror) as shown.

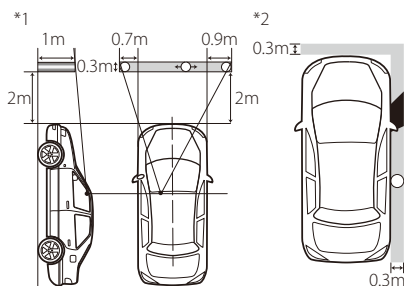

- ○ : Pole (height: 1m, diameter: 0.3m)
- ■ : Field of vision from steering position
- ■ : Exempted area (pole size is subject to regulation)

- For right hand drive vehicles, standards are reversed.

*1 The pole must be visible from the driver's position as direct forward field of vision.

*2 The pole must be directly visible or indirectly visible through the mirror, etc. from the driver's position.

■ Supplied accessories for installation

①		×1
②		×1
③		×1
④		×1
⑤		×1
⑥		×1
⑦		×4
⑧		×3
⑨		×5
⑩		×1
⑪		×1
⑫		×1
⑬		×1

■ Installation procedure

1. To prevent a short circuit, remove the key from the ignition and disconnect the ⊖ terminal of the battery.

2. Remove the vehicle parts for installing the unit and connecting wires to terminal.
3. Make the proper input and output wire connections for each unit.
4. Determine the height of the display unit and position of the slider. See **Distance between the display unit and the main unit (P.89)**.
5. Take Connector B on the wiring harness and connect it to the speaker connector in your vehicle.
6. Take Connector A on the wiring harness and connect it to the external power connector on your vehicle.
7. Connect the wiring harness connector to the unit.
8. Install the main unit to the vehicle.
9. Reinstall the vehicle parts.
10. Install the display unit.
11. Reconnect the ⊖ terminal of the battery.
12. Perform the Initial Setup.
See **Initial SETUP (P.12)**.

Installing the accessories

GPS antenna

GPS antenna is installed inside of the car. It should be installed as horizontally as possible to allow easy reception of the GPS satellite signals. To mount the GPS antenna inside your vehicle:

1. Clean your dashboard or other surface.
2. Remove the separator of the metal plate (accessory ⑤).
3. Press the metal plate (accessory ⑤) down firmly on your dashboard or other mounting surface. You can bend the metal plate (accessory ⑤) to conform to a curved surface, if necessary.
4. Remove the separator of the GPS antenna (accessory ④), and stick the antenna to the metal plate (accessory ⑤).

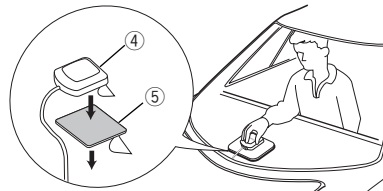

NOTE

- Use the supplied GPS antenna. Using the GPS antenna other than the supplied one may cause a drop in positioning accuracy.
- Depending on the type of car, reception of the GPS satellite signals might not be possible with an inside installation.
- Please install this GPS antenna in an area away from any antennas that are used with CB radios or satellite televisions.
- The GPS antenna should be installed at a position that is spaced at least 12 inch (30 cm) from smartphone/cell-phone or other transmitting antennas. Signals from the GPS satellite may be interfered with by these types of communication.
- Painting the GPS antenna with (metallic) paint may cause a drop in performance.

Microphone unit

1. Check the installation position of the microphone (accessory ③).
2. Clean the installation surface.
3. Remove the separator of the microphone (accessory ③), and stick the microphone to the place shown below.

Connection/Installation

4. Wire the microphone cable up to the unit with it secured at several positions using tape or other desired method.
5. Adjust the direction of the microphone (accessory ③) to the driver.

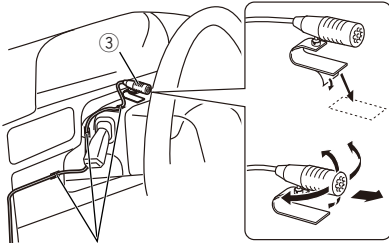

Fix a cable with a commercial item of tape.

Installing the Big Screen model

Confirm the installing position of the display unit

● Vehicles cannot be installed

It may be possible to install if it can avoid the following by adjustment for slider position and display height.

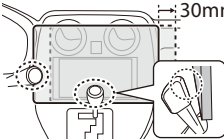
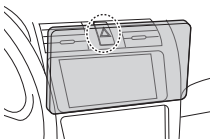
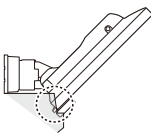
Lever operations are interfered such as shift lever, wiper lever, winker lever when install the unit.	A hazard switch is hidden from a driver seat.	The display unit hits a panel on the vehicle.
		

*1 The Display unit can move 30 mm to the left or right. It can be installed if it doesn't interfere with lever operation when moving.

● Distance between the display unit and the main unit

Adjust slider position and display height so that it does not interfere with display movement.

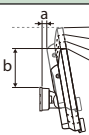
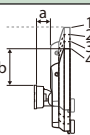
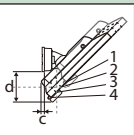
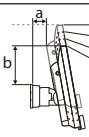
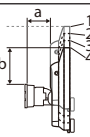
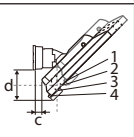
Slider position	Display angle															
	-10°				0°				45°							
Back position		a	b		a	b		c	d	1	2	3	4			
		1	10.8		126.5	1		30.0	123.6					1	25.6	30.5
		2	13.4		111.8	2			108.6					2	15.0	41.1
		3	16.0		97.2	3			93.6					3	4.4	51.7
Forward position		a	b		a	b		c	d	1	2	3	4			
		1	29.8		126.5	1		49.0	123.6					1	44.6	30.5
		2	32.4		111.8	2			108.6					2	34.0	41.1
		3	35.0		97.2	3			93.6					3	23.4	51.7
		4	37.6	82.4	4		78.6	4	12.8	62.3						

Unit: mm

● Main unit allowable installation angles

Installed horizontally

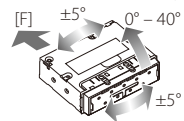

- [F] : Front side of the vehicle
- Pitch : 0° - 40° (horizontally), ±20° (vertically)
- Roll/Yaw : ±5°

Installed vertically

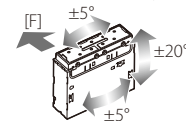

To install with the main unit separated from the display unit

- Depending on how the main unit is oriented, [Installation Orientation] may require configuring. (P.13)
- The KCA-A150EX extension cable (150 cm / 4.9 ft, sold separately) is required to connect the display unit (accessory ⑥).

Connection/Installation

Positioning the slider in forward

- 1 Remove the two screws from the top of the main unit.

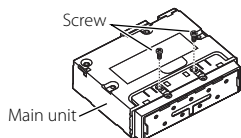

- 2 Remove the four screws from the bottom of the main unit.

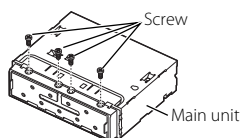

- 3 Pull the slider block forward and reinstall the four screws to the bottom of the main unit.

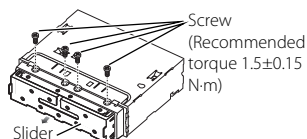

- 4 Reinstall the two screws from the top of the main unit.

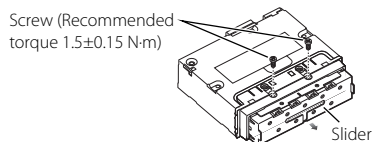

Installing the main unit

NOTE

- Determine the slider position before installing the main unit. **(P.90)** The slider position cannot be changed after installing to the vehicle.
- Make sure that the unit is installed securely in place. If the unit is unstable, it may malfunction.

- 1 Remove parts that interfere with installing such as a panel on the vehicle.

- 2 Install the vehicle mounting bracket to the main unit.

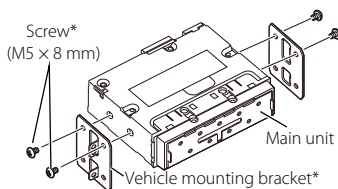

- 3 Connect the wiring harness wires and peripheral equipment.

- 4 Install the main unit to the vehicle.

- 5 Reinstall the removed parts such as a panel on the vehicle.

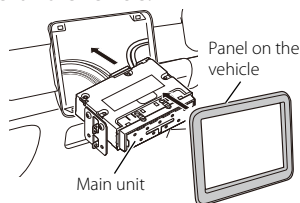

Installing the arm bracket for the display unit

- 1 Match the arm bracket (accessory ⑩) installation position to align with the length of the display cable.

Power cable for Display : about 170 mm (6-11/16")

Video cable for Display : about 160 mm (6-5/16")

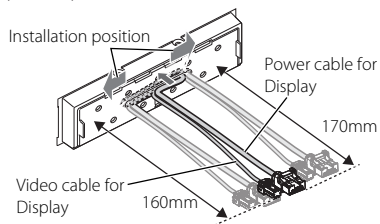

2 Positioning the arm bracket (accessory 10).

When installing the arm bracket in the left or right position, move the display cable so that it aligns with the groove in the arm bracket.

Center position

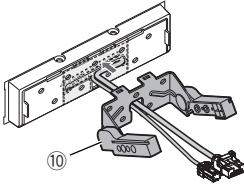

Left position

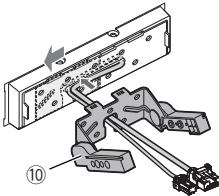

Right position

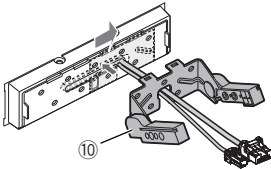

3 Fix the arm bracket (accessory 10) to the main unit with the five binding head screws (accessory 9).

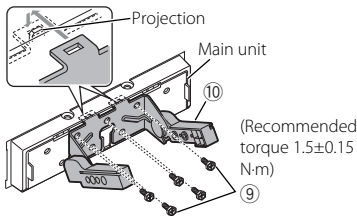

Installing the display unit and adjusting the height

1 Remove the rear cover from the display unit (accessory 6).

Slide the rear cover on the display unit (accessory 6) over and lift it up.

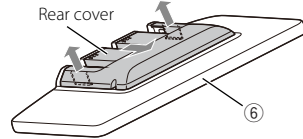

2 Connect the Video cable for Display (1) and Power cable for Display (2).

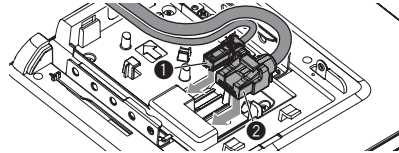

3 Run the display cables.

Use the guides to secure the Video cable for Display (1) in place.

Run the display cables along the interior guide path (between the posts). Install it so that the display unit has room to move. Tuck the remaining display cables inside the main unit.

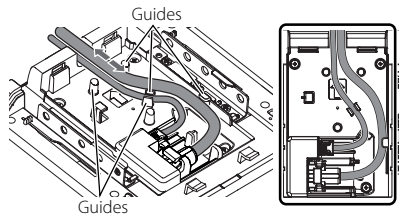

4 Install the display unit (accessory 6) to the main unit.

Install the unit so that the hooks on the display unit (accessory 6) are inserted into the groove on the arm bracket.

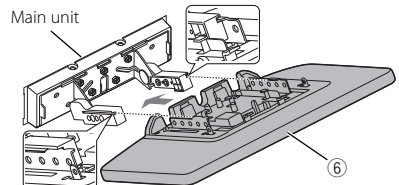

Connection/Installation

- 5** Adjust the display height according to the screw hole position.

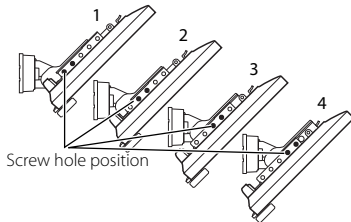

- 6** Fix the display unit with four hexagon head screws (accessory ⑦).

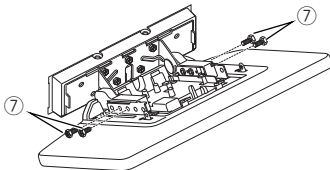

NOTE

- Fix with hexagon head screws correctly. After installing the display unit (accessory ⑥) to the main unit, tilt the display forward until it stops and confirm that the display unit (accessory ⑥) does not hit vehicle parts. If the display unit hits vehicle parts, adjust the display height again.

- 7** Adjust the length of the display cable to align with the height of the display unit.

Install it so that the display unit has room to move. Tuck the remaining display cable inside the main unit.

- 8** Attach the rear cover of the display unit. Insert the hooks on the rear cover into the grooves on the display unit. Slide it along the main unit until you hear a click.

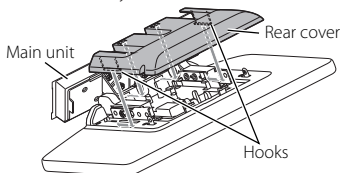

- 9** Fix the display unit cover with two binding head screws (accessory ⑧).

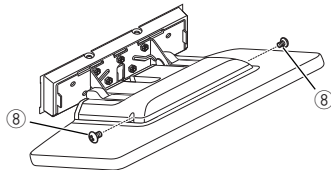

- 10** Raise the display manually.

Removing the display cable

⚠ CAUTION

- To prevent injuries to your hands and damage to the display cable, cover the metal parts with protective tape before working.
- Do not disconnect cables while the unit's power is on. Doing so could cause damage.

- 1** Apply protective tape so that it covers the metal parts in the shaded area in the image.

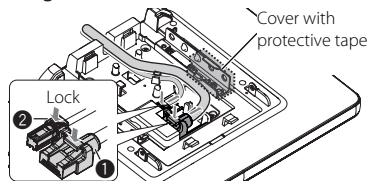

- 2** Press and hold the display cable lock and then remove the cable.

Disconnect the Power cable for Display (①) and Video cable for Display (②).

Connecting the unit

Connecting wires to terminals

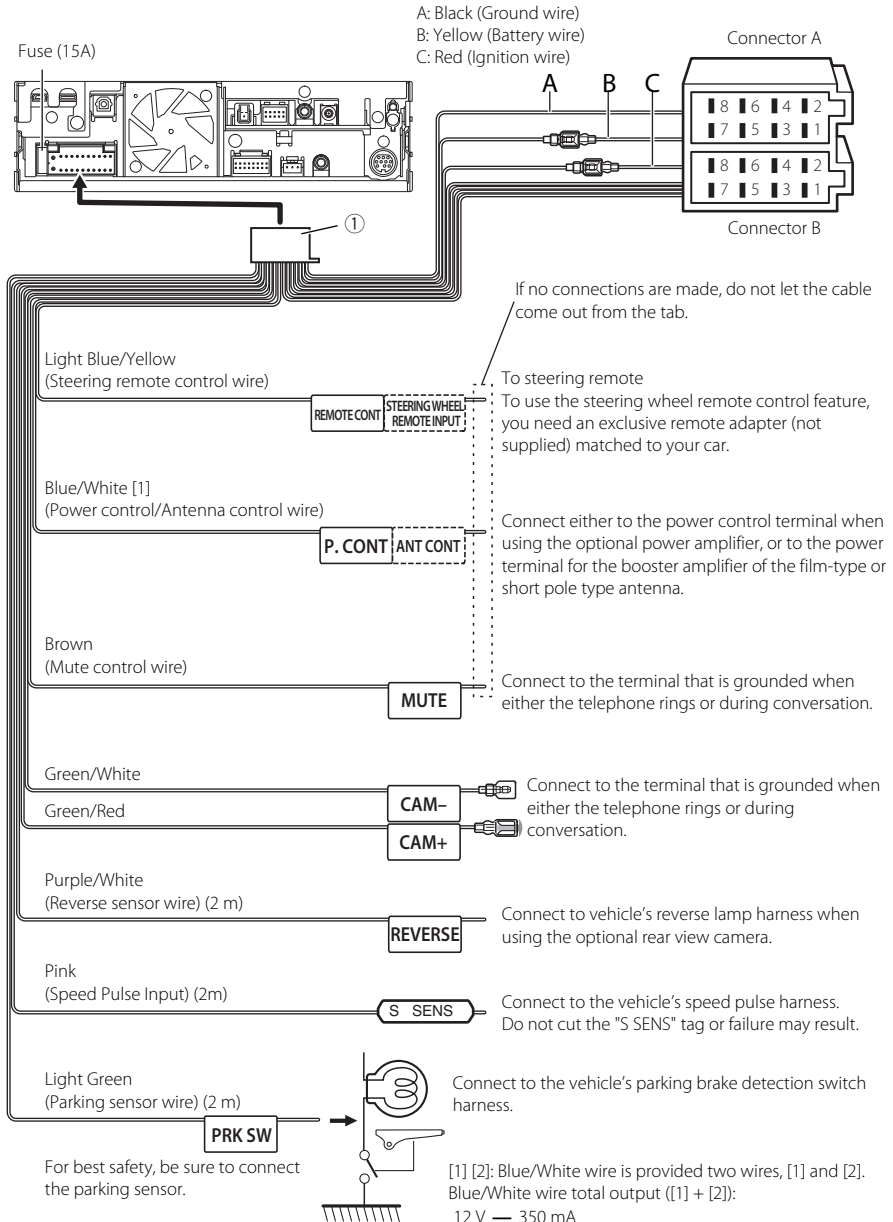

3-way speaker system setup

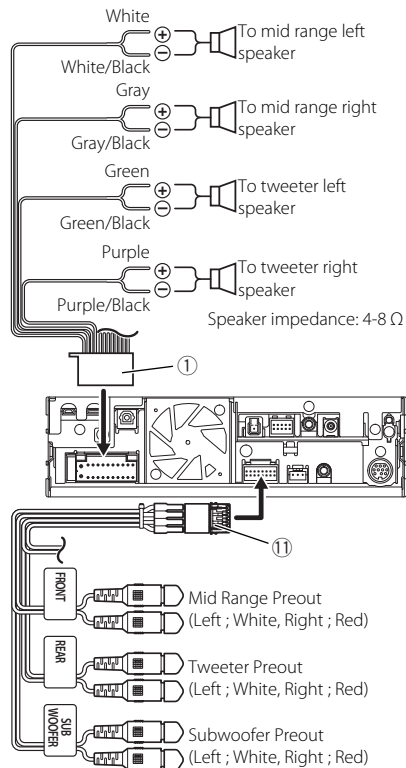

NOTE

- When connecting to an external amplifier, connect its ground wire to the car's chassis to avoid damaging the unit.
- For how to switch to the 3-way speaker system, see [X'over Network] in the System Configuration settings. (P.13)
- For speaker setup and crossover setup, see **Speaker / X'over setup (P.72)**.
- For how to connect speaker wires to terminals other than speaker terminals and Preout terminals, see **Connecting the external amplifiers and external AV device (P.95)** and **Connecting wires to terminals (P.93)**.
- When not using the Preout (RCA) terminals, keep the terminal caps on.

Wiring harness connector function guide

Wiring harness (Accessory ①)

Pin	Color and function	
A-4	Yellow	Battery
A-5	Blue/White [2]	Power Control
A-6	Orange/White	Dimmer
A-7	Red	Ignition (ACC)
A-8	Black	Earth (Ground) Connection
B-1/B-2	Purple (+) / Purple/Black (-)	Rear Right
B-3/B-4	Gray (+) / Gray/Black (-)	Front Right
B-5/B-6	White (+) / White/Black (-)	Front Left
B-7/B-8	Green (+) / Green/Black (-)	Rear Left

* Speaker Impedance: 4-8 Ω

* [1] [2]: Blue/White wire is provided two wires, [1] and [2]. Blue/White wire total output ([1] + [2]): 12 V \approx 350 mA

⚠ WARNING for Connecting the ISO Connector

The pin arrangement for the ISO connectors depends on the type of vehicle you drive. Make sure to make the proper connections to prevent damage to the unit. The default connection for the wiring harness is described in (1) below. If the ISO connector pins are set as described in (2), make the connection as illustrated. Please be sure to reconnect the cable as shown (2) below to install this unit to the Volkswagen vehicles etc.

(1): Default setting

The red (A-7 pin) of the vehicle's ISO connector is linked with the ignition, and the yellow (A-4 pin) is connected to the constant power supply.

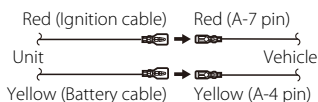

(2)

The red (A-7 pin) of the vehicle's ISO connector is connected to the constant power supply, and the yellow (A-4 pin) is linked to the ignition.

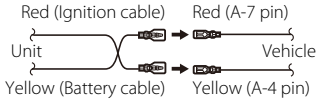

Connecting the external amplifiers and external AV device

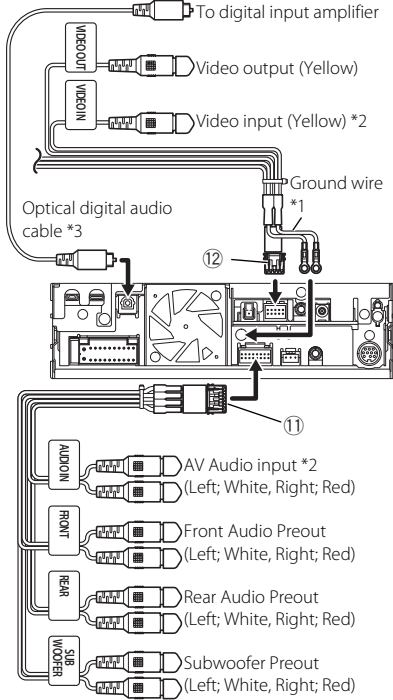



- *1 Secure the two ground wires together to the chassis of the main unit.
- *2 Set "VIDEO IN" to "None" in Camera Assignment Settings. (P.58)
- *3 Sold separately.
Check the specifications for the optical digital audio cable and follow the minimum bending radius when running the wires.

NOTE

- When connecting to an external amplifier, connect its ground wire to the car's chassis to avoid damaging the unit.
- When not using the Preout (RCA terminals), keep the terminal caps on.

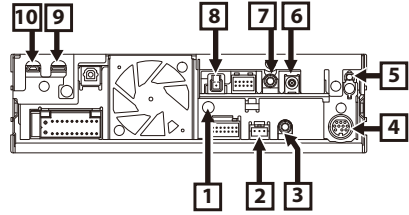
Connecting the system and external components

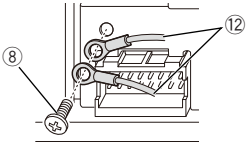
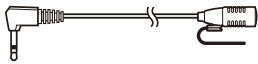
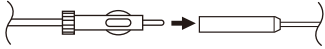

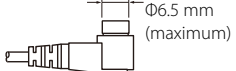
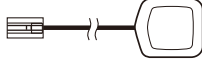
1	Secure both ground wires from accessory ⑫ together to the chassis as show in the diagram below. 
2	Dashboard camera interface Connect a Dashboard Camera DRV-N520 (optional accessory). (P.97)
3	Accessory ③ : Microphone 
4	External I/F
5	FM/AM antenna input 
6	Digital Radio antenna CX-DAB1 (Optional accessory)  Use of a CX-DAB1 (optional accessory) as a Digital Radio antenna is recommended. When using a commercially available Digital Radio antenna, the diameter of the SMB connector must be $\Phi 6.5$ mm or less. 
7	Connect to vehicle's steering remote harness. Contact your KENWOOD dealer for details.
8	Accessory ④ : GPS Antenna Use the supplied GPS antenna. Using the GPS antenna other than the supplied one may cause a drop in positioning accuracy. 
9	USB terminal (USB Type-C®)

Connection/Installation

- 10 HDMI input (Type-D)
Connect a KCA-HD200 (optional accessory) to HDMI input terminal.

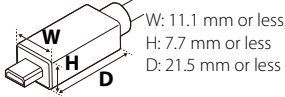

Installation/removal of fixing bracket

When you connect the cable to HDMI terminal and USB terminal, remove the fixture. After connecting the cable, put the fixture again.

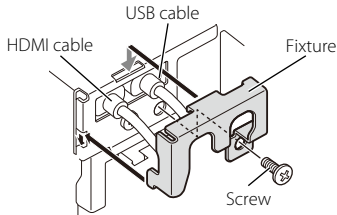

Connecting an iPhone

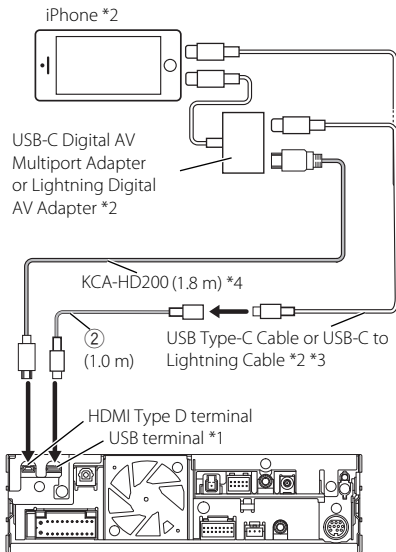

- *1 USB maximum power supply current : DC 5 V
= 3.0 A
- *2 Sold separately.
- *3 Depending on the iPhone connector, use a genuine Apple Lightning-USB cable or a USB-IF certified USB-C® cable.

If you use non-certified cable, it may not work properly.

*4 Optional accessory

Connecting an Android™ smartphone

Android smartphone *2

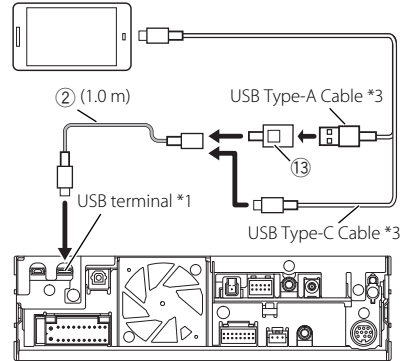

- *1 USB maximum power supply current : DC 5 V
= 3.0 A
- *2 Sold separately.
- *3 Use USB-IF certified USB cable.

Connecting a USB device

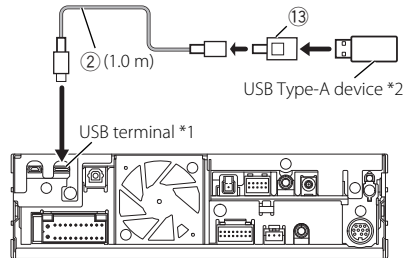

- *1 USB maximum power supply current : DC 5 V
= 3.0 A
- *2 Sold separately.

Connecting the camera

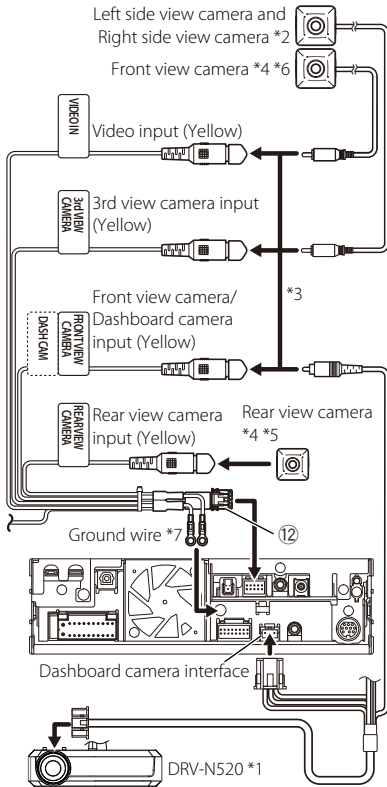

- *1 Optional accessory
- *2 Sold separately.
- *3 Up to 3 cameras of Dashboard camera, Front view camera, Left side view camera and Right side view camera can be connected. For more information, see **To set up the camera assignment settings (P.58)**.
- *4 CMOS-3xx series (optional accessory) or commercially available camera.
- *5 For HD video, connect an HD camera to Rear view camera input terminal.
- *6 For HD video, connect an HD camera to Front view camera/Dashboard camera input terminal.
- *7 Secure both ground wires to the same terminal.

Troubleshooting

Problems and Solutions

If any trouble occurs, first check the following table for possible problems.

NOTE

- Some functions of this unit may be disabled by some settings made on this unit.
- What might seem to be a malfunction in your unit may just be the result of slight misoperation or miswiring.

About settings

- **Cannot set up the subwoofer.**
- **Cannot set up subwoofer phase.**
- **No output from the subwoofer.**
- **Cannot set up the low pass filter.**
- **Cannot set up the high pass filter.**

Subwoofer is not set to on.

Set the subwoofer to on. See *Speaker / X'over setup (P.72)*.

About audio operations

Radio reception is poor.

The car antenna is not extended.

Pull out the antenna all the way.

The antenna control wire is not connected.

Connect the wire correctly. See *Connecting the system and external components (P.95)*.

Cannot select a folder.

The random play function is enabled.

Turn off the random function.

The unit does not respond when you try to perform a operation during USB mirroring.

A connector is not properly connected.

Unplug the smartphone from the USB terminal, then reattach the smartphone again.

Others

The Touch Sensor Tone doesn't sound.

The preout jack is being used.

The Touch Sensor Tone cannot be output from the preout jack.

Error Messages

When you fail to operate the unit correctly, the cause of the failure appears as the message on the screen.

There is an error in the speaker wiring. Please check the connections.

Protective circuit has been activated because a speaker cord has shorted or it has come in contact with the car chassis.

Wire or insulate the speaker cord as appropriate and turn the power off and on again.

No Device (USB device)

The USB device is selected as a source although no USB device is connected.

Change the source to any source other than USB/iPhone. Connect a USB device, and change the source to USB again.

Disconnected (iPhone, Bluetooth audio player)

The iPhone/Bluetooth audio player is selected as a source although no iPhone/Bluetooth audio player is connected.

Change the source to any source other than iPhone/Bluetooth. Connect an iPhone/Bluetooth audio player, and change the source to iPhone/Bluetooth again.

No Media file

The connected USB device contains no playable audio file. Media was played that does not have data recorded that the unit can play.

See *Playable Media and Files (P.100)* and try another USB device.

USB device over current status detected.

The connected USB device is rated a current capacity higher than the allowable limit.

Check the USB device. Some trouble may have occurred to the connected USB device.

Change the source to any source other than USB. Remove the USB device.

The speed sense wire is not connected. Please check the connection.

The speed pulse disconnection is detected. By default, it is treated as connected.

To improve precision of a vehicle position recognition, check the connection of the speed pulse.

Starting tuner failed.

The tuner unit is not operating correctly due to some reason or other.

Turn the power off and on again. If the “Starting tuner failed.” message does not disappear, contact your nearest KENWOOD dealer.

Audio output has stopped due to an error. Please restart the system.

If the issue persists, contact customer support.

An error causes audio output to stop.

Reset the system. If resetting the system does not resolve the issue, please contact the customer support center.

 **Apple CarPlay**

The GPS antenna must be connected to use Apple CarPlay wirelessly. Please verify the proper connections or plug in by USB to use Apple CarPlay.

The GPS antenna is not connected when the Apple CarPlay is started by connecting wirelessly or when the iPhone compatible with wireless Apple CarPlay is registered in [Device List].

Check the connection of the GPS antenna or plug in over USB to use Apple CarPlay.

Appendix

Playable Media and Files

You can play various kinds of media and files on this unit.

About files

The following audio and video files are supported.

Playable Audio files

	Format	Bit rate	Sampling frequency	Bit count
AAC-LC (.m4a)	MPEG-2/MPEG-4 AAC LC HE-AAC(V1,V2)	8 – 320kbps, VBR	16 – 48 kHz	16 bit
MP3 (.mp3)	MPEG-1/MPEG-2 Audio Layer 3	8 – 320kbps, VBR	16 – 48 kHz	16 bit
WMA (.wma)	Windows Media Audio Standard L3 profile (Version 7,8,9)	8 – 320kbps	16 – 48 kHz	16 bit
Linear PCM (WAVE) (.wav)	RIFF waveform Audio Format	–	16 – 192 kHz	16 bit/24 bit
FLAC (.flac)	flac	–	16 – 192 kHz	16 bit/24 bit
Vorbis (.ogg)	vorbis	–	16 – 48 kHz	16 bit

- WMA and AAC files with DRM cannot be played.
- Although the audio files complies with the standards listed above, they may not be played depending on the types or conditions of media or device.
- This unit supports playback of High-Resolution Audio files.
It is recommended that a car audio system should be configured with all High-Resolution Audio compatible products from player to speaker to enjoy its high quality sound.

Acceptable Video files

	Profile	Max. Picture size	Max. bit rate	Audio format
MPEG-1 (.mpg, .mpeg)	–	352 × 240, 352 × 288	1.5 Mbps	MPEG Audio Layer 2
MPEG-2 (.mpg, .mpeg)	MP@ML	720 × 480, 720 × 576	8 Mbps	MPEG Audio Layer 2
H.264/MPEG-4 AVC (.mp4, .m4v, .avi, .flv, .f4v)	Baseline Profile, Main Profile	1920 × 1080 (30 fps)	8 Mbps	MP3, AAC
MPEG-4 (.mp4, .avi)	Advanced Simple Profile	1920 × 1080 (30 fps)	8 Mbps	MP3, AAC
WMV (.wmv)	Main Profile	1920 × 1080 (30 fps)	8 Mbps	WMA
MKV (.mkv)	Video format follows H.264/MPEG-4 AVC, MPEG-4, WMV			MP3, AAC, WMA, Vorbis, FLAC

Limitation on structure of file and folder

	USB device
Maximum number of folder layers	8
Maximum number of files (per folder)	9999

	USB device
Maximum number of folders (per folder)	9999
Maximum number of folders (per device)	Unlimited

- You can enter a folder name and file name with 255 or fewer single-byte characters.
- Files in the folder whose folder name begins with a dot (.) cannot be played.

Specifications

■ Monitor section

Picture Size

: 10.1 inches (diagonal) wide
: 223.7 mm (W) × 125.8 mm (H)

Display System

: LCD panel

Drive System

: TFT active matrix system

Number of Pixels

: 2,764,800 (1280H × 720V × RGB)

Effective Pixels

: 99.99 %

Pixel Arrangement

: RGB striped arrangement

Back Lighting

: LED

■ USB interface section

Connector type

: Type-C

USB Standard

: USB 2.0 High Speed

File System

: FAT16, FAT32, exFAT, NTFS

Maximum Power Supply Current

: DC 5 V $\overline{\text{---}}$ 3.0 A

D/A Converter

: 24 bit / 32 bit

Audio Decoder

: MP3 / WMA / AAC / WAV / FLAC / Vorbis

Video Decoder

: MPEG-1 / MPEG-2 / MPEG-4 / WMV / H.264 / MKV

Frequency Response

- 192 kHz : 20 – 88,000 Hz
- 96 kHz : 20 – 44,000 Hz
- 48 kHz : 20 – 22,000 Hz
- 44.1 kHz : 20 – 20,000 Hz

Total Harmonic Distortion

: 0.01 % (1 kHz)

S/N Ratio (dB)

: 98.5 dB

Dynamic Range

: 89 dB

■ Wireless Mirroring section

Mode

: Sink

Copyright protection

: HDCP2.2

Touch Control

: UIBC

■ Wi-Fi section

IEEE Standard

: 802.11 a/b/g/n/ac

Frequency Range

: Dual Band (2.4GHz/5GHz)

Channels

: Auto (1-11ch) / Auto (149,153,157,161ch)

Transfer rates (MAX)

: 11a: 54 Mbps / 11b: 11 Mbps / 11g: 54 Mbps /
11n: 300 Mbps / 11ac: 867 Mbps

Output Power (E.I.R.P.) (MAX)

- 2.4 GHz/SISO
: 11b: 8 dBm / 11g: 3 dBm /
11n (20 MHz): 3 dBm
- 5 GHz/SISO
: 11a: 3 dBm /
11n (20 MHz)/11ac (20 MHz): 3 dBm /
11n (40 MHz)/11ac (40 MHz): 3 dBm /
11ac (80 MHz): 3 dBm
- 5 GHz/MIMO
: 11n (20 MHz)/11ac (20 MHz): 4 dBm /
11n (40 MHz)/11ac (40 MHz): 5 dBm /
11ac (80 MHz): 4 dBm

■ Bluetooth section

Technology

: Bluetooth Ver.5.2

Frequency

: 2.402 – 2.480 GHz

RF Output Power (E.I.R.P.) (MAX)

: -11 dBm, Power Class 2

Maximum Communication range

: Line of sight approx. 10m (32.8 ft)

Audio Codec

: LDAC/SBC/AAC

Profile (Multi Profile support)

- HFP (V1.7) (Hands Free Profile)
- SPP (Serial Port Profile)
- A2DP (Advanced Audio Distribution Profile)
- AVRCP (V1.6) (Audio/Video Remote Control Profile)
- PBAP (Phonebook Access Profile)

■ HDMI section**HDMI**

: Type-D

Input Resolution

- VGA (640x480p @59.94Hz/60Hz)
- 480p (720x480p @59.94Hz/60Hz)
- 720p (1280x720p @59.94Hz/60Hz)

Input Audio Type

: 32k/44.1k/48k/88.2k/96k/176.2k/192k Hz
16 bit/20 bit/24 bit Linear PCM

■ DSP section**Graphics equalizer**

- Band: 13 Band
- Frequency (BAND1 – 13)
: 62.5/100/160/250/400/630/1k/1.6k/2.5k/4k/
6.3k/10k/16k Hz

Gain

: -9/-8/-7/-6/-5/-4/-3/-2/-1/0/1/2/3/4/5/6/7/8/9
dB

2-way X'Over

- High pass filter
 - Frequency: Through,
30/40/50/60/70/80/90/100/120/150/180/2
20/250 Hz
 - Slope: -6/-12/-18/-24 dB/Oct.
- Low pass filter
 - Frequency:
30/40/50/60/70/80/90/100/120/150/180/2
20/250 Hz, Through
 - Slope: -6/-12/-18/-24 dB/Oct.

3-way X'Over

- High pass filter
 - Frequency: 250/300/1k/1.6k/2.5k/4k/5k/
6.3k/8k/10k/12.5k Hz

– Slope: -12/-18/-24 dB/Oct.

- Band pass filter
 - Frequency:
Through,
50/60/70/80/90/100/120/150/180/220/250
/300 Hz
 - Slope: -12/-18/-24 dB/Oct.
- Low pass filter
 - Frequency:
250/300/1k/1.6k/2.5k/4k/5k/6.3k/8k Hz,
Through
 - Slope: -12/-18/-24 dB/Oct.

Position

- Front / Rear /Subwoofer Delay
: 0 – 6.1 m (0.01 m Step)

- Gain
: -8 – 0 dB

Subwoofer level

: -50 – +10 dB

■ Digital Radio section**Frequency Range**

BAND III: 174.928 – 239.200 (MHz)

Sensitivity

: -100 dBm

S/N Ratio (dB)

: 90 dB

■ Digital Antenna Connector section**Connector type**

: SMB

Output Voltage (9 – 10.5V)

: 9.8 V DC

Maximum Current

: < 100 mA

■ FM tuner section**Frequency Range (step)**

: 87.5 MHz - 108.0 MHz (50 kHz)

Usable Sensitivity (S/N : 30 dB)

: 7.3 dBf (0.7 μ V/75 Ω)

Frequency Response

: 30 Hz – 15 kHz

Appendix

S/N Ratio (dB)

: 70 dB (MONO)

Selectivity (\pm 400 kHz)

: 80 dB

Stereo Separation

: 45 dB (1 kHz)

■ AM tuner section

Frequency Range (step)

- LW: 153 – 279 kHz (9 kHz)
- MW: 531 – 1611 kHz (9 kHz)

Usable Sensitivity

- MW: 31 μ V
- LW: 50 μ V

■ Video section

Color System of External Video Input

: NTSC/PAL

External video input level (RCA jacks)

: 1 V_{p-p}/75 k Ω

Video Input Level (RCA jacks)

: 1 V_{p-p}/75 Ω

Video Output Level (RCA jacks)

: 1 V_{p-p}/75 Ω

■ Audio section

Maximum Power (Front & Rear)

: 50 W \times 4

Typical Power Output (Front & Rear)

: 29 W \times 4 (4 Ω , 1 kHz, 10% THD)

Output frequency band

: 20 – 88,000 Hz

Preout Level (V)

: 5 V / 10 k Ω

Preout Impedance

: \leq 300 Ω

Speaker Impedance

: 4 – 8 Ω

External Audio Max Input Level (RCA jacks)

: 2 V / 22 k Ω

■ Digital Audio Out

Connector Type

: OPTICAL

Output frequency

: 48 kHz / 96 kHz, 24 bit, Linear PCM

■ General

Operating Voltage

: 12 V DC car battery

Dimensions (W \times H \times D)

- Chassis
: 178 \times 50 \times 158 mm
- Monitor
: 262 \times 181 \times 52 mm

Weight

- : 2.5 kg
- Chassis
: 1.3 kg
- Monitor
: 1.1 kg

NOTE

- Although the effective pixels for the liquid crystal panel is given as 99.99% or more, 0.01% of pixels may not light or may light incorrectly.

Specifications are subject to change without prior notice.

About this Unit

Trademarks and licenses

- The Bluetooth® word mark and logos are registered trademarks owned by Bluetooth SIG, Inc. and any use of such marks by JVC/KENWOOD Corporation is under license. Other trademarks and trade names are those of their respective owners.
- LDAC and LDAC logo are trademarks of Sony Corporation.
- Hi-Res Audio logo and Hi-Res Audio Wireless logo are used under license from Japan Audio Society.



- Windows Media is a registered trademark or trademark of Microsoft Corporation in the United States and/or other countries. This product is protected by certain intellectual property rights of Microsoft. Use or distribution of such technology outside of this product is prohibited without a license from Microsoft.
- This software is based in part on the work of the independent JPEG Group.
- Use of the Made for Apple badge means that an accessory has been designed to connect specifically to the Apple product(s) identified in the badge, and has been certified by the developer to meet Apple performance standards. Apple is not responsible for the operation of this device or its compliance with safety and regulatory standards. Please note that the use of this accessory with an Apple product may affect wireless performance.
- Apple, Apple CarPlay, Apple Music, iPhone, Lightning, and Siri are trademarks of Apple Inc., registered in the U.S. and other countries and regions.
- Use of the Apple CarPlay logo means that a vehicle user interface meets Apple performance standards. Apple is not responsible for the operation of this vehicle or its compliance with safety and regulatory standards. Please note that the use of this product with iPhone, iPod, or iPad may affect wireless performance.

- App Store is a service mark of Apple Inc., registered in the U.S. and other countries.
- IOS is a trademark or registered trademark of Cisco in the U.S. and other countries and is used under license.
- Google, Android, Android Auto, Google Play and other marks are trademarks of Google LLC. Wireless use of Android Auto requires a compatible Android 11.0+ phone and compatible active data plan. Check g.co/androidauto/requirements for compatibility.
- Wi-Fi® is a registered trademark of Wi-Fi Alliance®.
- The Wi-Fi CERTIFIED™ Logo is a certification mark of Wi-Fi Alliance®.
- USB Type-C® and USB-C® are registered trademarks of USB Implementers Forum.
- The terms HDMI and HDMI High-Definition Multimedia Interface, and the HDMI Logo are trademarks or registered trademarks of HDMI Licensing Administrator, Inc. in the United States and other countries.
- This product includes FontAvenue® fonts licenced by NEC Corporation. FontAvenue is a registered trademark of NEC Corporation.

FontAvenue

- This product includes "Ubiquitous QuickBoot™" technology developed by Ubiquitous AI Corporation. Ubiquitous QuickBoot™ is a trademark of Ubiquitous AI Corporation. Copyright© 2025 Ubiquitous AI Corporation All rights reserved.



- THIS PRODUCT IS LICENSED UNDER THE AVC PATENT PORTFOLIO LICENSE FOR THE PERSONAL USE OF A CONSUMER OR OTHER USES IN WHICH IT DOES NOT RECEIVE REMUNERATION TO (i) ENCODE VIDEO IN COMPLIANCE WITH THE AVC STANDARD ("AVC VIDEO") AND/OR (ii) DECODE AVC VIDEO THAT WAS ENCODED BY A

CONSUMER ENGAGED IN A PERSONAL ACTIVITY AND/OR WAS OBTAINED FROM A VIDEO PROVIDER LICENSED TO PROVIDE AVC VIDEO. NO LICENSE IS GRANTED OR SHALL BE IMPLIED FOR ANY OTHER USE. ADDITIONAL INFORMATION MAY BE OBTAINED FROM MPEG LA, L.L.C. SEE HTTP://WWW.MPEGLA.COM

- THIS PRODUCT IS LICENSED UNDER THE VC-1 PATENT PORTFOLIO LICENSE FOR THE PERSONAL AND NON-COMMERCIAL USE OF A CONSUMER TO (i) ENCODE VIDEO IN COMPLIANCE WITH THE VC-1 STANDARD ("VC-1 VIDEO") AND/OR (ii) DECODE VC-1 VIDEO THAT WAS ENCODED BY A CONSUMER ENGAGED IN A PERSONAL AND NON-COMMERCIAL ACTIVITY AND/OR WAS OBTAINED FROM A VIDEO PROVIDER LICENSED TO PROVIDE VC-1 VIDEO. NO LICENSE IS GRANTED OR SHALL BE IMPLIED FOR ANY OTHER USE. ADDITIONAL INFORMATION MAY BE OBTAINED FROM MPEG LA, L.L.C. SEE HTTP://WWW.MPEGLA.COM

- libFLAC

Copyright (C) 2000-2009 Josh Coalson
Copyright (C) 2011-2013 Xiph.Org
Foundation

Redistribution and use in source and binary forms, with or without modification, are permitted provided that the following conditions are met:

- Redistributions of source code must retain the above copyright notice, this list of conditions and the following disclaimer.
- Redistributions in binary form must reproduce the above copyright notice, this list of conditions and the following disclaimer in the documentation and/or other materials provided with the distribution.
- Neither the name of the Xiph.org Foundation nor the names of its contributors may be used to endorse or promote products derived from this software without specific prior written permission.

THIS SOFTWARE IS PROVIDED BY THE COPYRIGHT HOLDERS AND CONTRIBUTORS "AS IS" AND ANY EXPRESS OR IMPLIED WARRANTIES, INCLUDING, BUT NOT LIMITED TO, THE IMPLIED WARRANTIES OF MERCHANTABILITY AND FITNESS FOR A PARTICULAR PURPOSE ARE DISCLAIMED. IN NO EVENT SHALL THE FOUNDATION OR CONTRIBUTORS BE LIABLE FOR ANY DIRECT, INDIRECT, INCIDENTAL, SPECIAL, EXEMPLARY, OR CONSEQUENTIAL DAMAGES (INCLUDING, BUT NOT LIMITED TO, PROCUREMENT OF SUBSTITUTE GOODS OR SERVICES; LOSS OF USE, DATA, OR PROFITS; OR BUSINESS INTERRUPTION) HOWEVER CAUSED AND ON ANY THEORY OF LIABILITY, WHETHER IN CONTRACT, STRICT LIABILITY, OR TORT (INCLUDING NEGLIGENCE OR OTHERWISE) ARISING IN ANY WAY OUT OF THE USE OF THIS SOFTWARE, EVEN IF ADVISED OF THE POSSIBILITY OF SUCH DAMAGE.

- libvorbis

Copyright (c) 2002-2008 Xiph.org Foundation
Redistribution and use in source and binary forms, with or without modification, are permitted provided that the following conditions are met:

- Redistributions of source code must retain the above copyright notice, this list of conditions and the following disclaimer.
- Redistributions in binary form must reproduce the above copyright notice, this list of conditions and the following disclaimer in the documentation and/or other materials provided with the distribution.
- Neither the name of the Xiph.org Foundation nor the names of its contributors may be used to endorse or promote products derived from this software without specific prior written permission.

THIS SOFTWARE IS PROVIDED BY THE COPYRIGHT HOLDERS AND CONTRIBUTORS "AS IS" AND ANY EXPRESS OR IMPLIED WARRANTIES, INCLUDING, BUT NOT LIMITED TO, THE IMPLIED WARRANTIES OF MERCHANTABILITY AND FITNESS FOR A PARTICULAR PURPOSE ARE DISCLAIMED. IN NO EVENT SHALL THE FOUNDATION OR CONTRIBUTORS BE LIABLE FOR ANY DIRECT, INDIRECT, INCIDENTAL, SPECIAL,

EXEMPLARY, OR CONSEQUENTIAL DAMAGES (INCLUDING, BUT NOT LIMITED TO, PROCUREMENT OF SUBSTITUTE GOODS OR SERVICES; LOSS OF USE, DATA, OR PROFITS; OR BUSINESS INTERRUPTION) HOWEVER CAUSED AND ON ANY THEORY OF LIABILITY, WHETHER IN CONTRACT, STRICT LIABILITY, OR TORT (INCLUDING NEGLIGENCE OR OTHERWISE) ARISING IN ANY WAY OUT OF THE USE OF THIS SOFTWARE, EVEN IF ADVISED OF THE POSSIBILITY OF SUCH DAMAGE.

- libogg

Copyright (c) 2002, Xiph.org Foundation
Redistribution and use in source and binary forms, with or without modification, are permitted provided that the following conditions are met:

- Redistributions of source code must retain the above copyright notice, this list of conditions and the following disclaimer.
- Redistributions in binary form must reproduce the above copyright notice, this list of conditions and the following disclaimer in the documentation and/or other materials provided with the distribution.
- Neither the name of the Xiph.org Foundation nor the names of its contributors may be used to endorse or promote products derived from this software without specific prior written permission.

THIS SOFTWARE IS PROVIDED BY THE COPYRIGHT HOLDERS AND CONTRIBUTORS ``AS IS'' AND ANY EXPRESS OR IMPLIED WARRANTIES, INCLUDING, BUT NOT LIMITED TO, THE IMPLIED WARRANTIES OF MERCHANTABILITY AND FITNESS FOR A PARTICULAR PURPOSE ARE DISCLAIMED. IN NO EVENT SHALL THE FOUNDATION OR CONTRIBUTORS BE LIABLE FOR ANY DIRECT, INDIRECT, INCIDENTAL, SPECIAL, EXEMPLARY, OR CONSEQUENTIAL DAMAGES (INCLUDING, BUT NOT LIMITED TO, PROCUREMENT OF SUBSTITUTE GOODS OR SERVICES; LOSS OF USE, DATA, OR PROFITS;

OR BUSINESS INTERRUPTION) HOWEVER CAUSED AND ON ANY THEORY OF LIABILITY, WHETHER IN CONTRACT, STRICT LIABILITY, OR TORT (INCLUDING NEGLIGENCE OR OTHERWISE) ARISING IN ANY WAY OUT OF THE USE OF THIS SOFTWARE, EVEN IF ADVISED OF THE POSSIBILITY OF SUCH DAMAGE.

Safety Information

- Information on Disposal of Old Electrical and Electronic Equipment and Batteries (applicable for EU countries that have adopted separate waste collection systems)

Products and batteries with the symbol (crossed-out wheeled bin) cannot be disposed as household waste.

Old electrical and electronic equipment and batteries should be recycled at a facility capable of handling these items and their waste byproducts.

Contact your local authority for details in locating a recycle facility nearest to you. Proper recycling and waste disposal will help conserve resources whilst preventing detrimental effects on our health and the environment.

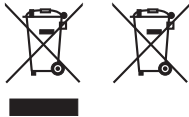

Declaration of Conformity with regard to the RE Directive 2014/53/EU

Declaration of Conformity with regard to the RoHS Directive 2011/65/EU

Manufacturer:

JVCKENWOOD Corporation
3-12, Moriyacho, Kanagawa-ku, Yokohama-shi,
Kanagawa 221-0022, JAPAN

EU Representative:

JVCKENWOOD Europe B.V.
Remdentsweg 20 B-9, 3641 SL Mijdrecht, THE
NETHERLANDS

English

Hereby, JVCKENWOOD declares that the radio equipment DMX9724XDS is in compliance with Directive 2014/53/EU. The full text of the EU declaration of conformity is available at the following internet address:

Français

Par la présente, JVCKENWOOD déclare que l'équipement radio DMX9724XDS est conforme à la directive 2014/53/UE. L'intégralité de la déclaration de conformité UE est disponible à l'adresse Internet suivante :

Deutsch

Hiermit erklärt JVCKENWOOD, dass das Funkgerät DMX9724XDS der Richtlinie 2014/53/EU entspricht. Der volle Text der EU-Konformitätserklärung steht unter der folgenden Internetadresse zur Verfügung:

Nederlands

Hierbij verklaart JVCKENWOOD dat de radioapparatuur DMX9724XDS in overeenstemming is met Richtlijn 2014/53/EU. De volledige tekst van de EU-verklaring van overeenstemming is te vinden op het volgende internetadres:

Italiano

Con la presente, JVCKENWOOD dichiara che l'apparecchio radio DMX9724XDS è conforme alla Direttiva 2014/53/UE. Il testo integrale della dichiarazione di conformità UE è disponibile al seguente indirizzo internet:

Español

Por la presente, JVCKENWOOD declara que el equipo de radio DMX9724XDS cumple la Directiva 2014/53/UE. El texto completo de la declaración de conformidad con la UE está disponible en la siguiente dirección de internet:

Português

Deste modo, a JVCKENWOOD declara que o equipamento de rádio DMX9724XDS está em conformidade com a Diretiva 2014/53/UE. O texto integral da declaração de conformidade da UE está disponível no seguinte endereço de internet:

Polska

Niniejszym, JVCKENWOOD deklaruje, że sprzęt radiowy DMX9724XDS jest zgodny z dyrektywą 2014/53/UE. Pełny tekst deklaracji zgodności EU jest dostępny pod adresem:

Český

Společnost JVCKENWOOD tímto prohlašuje, že rádiové zařízení DMX9724XDS splňuje podmínky směrnice 2014/53/EU. Plný text EU prohlášení o shodě je dostupný na následující internetové adrese:

Magyar

JVCKENWOOD ezennel kijelenti, hogy a DMX9724XDS rádióberendezés megfelel a 2014/53/EU irányelvnek. Az EU konformitási nyilatkozat teljes szövege az alábbi weboldalon érhető el:

Hrvatski

JVCKENWOOD ovim izjavljuje da je radio oprema DMX9724XDS u skladu s Direktivom 2014/53/EU. Cjeloviti tekst deklaracije Europske unije o usklađenosti dostupan je na sljedećoj internet adresi:

Svenska

Härmed försäkras JVCKENWOOD att radioutrustningen DMX9724XDS är i enlighet med direktiv 2014/53 / EU. Den fullständiga texten av EU-försäkran om överensstämmelse finns på följande Internetadress :

Suomi

JVCKENWOOD julistaa täten, että radiolaitte DMX9724XDS on direktiivin 2014/53/EU mukainen. EU-vaatimustenmukaisuusvakuutus löytyy kokonaisuudessaan seuraavasta internet-osoitteesta:

Slovensko

S tem JVCKENWOOD izjavlja, da je radijska oprema DMX9724XDS v skladu z Direktivo 2014/53/EU. Celotno besedilo direktive EU o skladnosti je dostopno na tem spletnem naslovu:

Slovensky

Spoločnosť JVCKENWOOD týmto vyhlasuje, že rádiové zariadenie DMX9724XDS vyhovuje smernici 2014/53/EÚ. Celý text EÚ vyhlásenia o zhode nájdete na nasledovnej internetovej adrese:

Dansk

Herved erklærer JVCKENWOOD, at radioudstyret DMX9724XDS er i overensstemmelse med Direktiv 2014/53/EU. EU-overensstemmelseserklæringens fulde ordlyd er tilgængelig på følgende internetadresse:

Norsk

JVCKENWOOD erklærer herved at radioustyret DMX9724XDS er i samsvar med Direktiv 2014/53/EU. Den fullstendige teksten til EU-konformitetserklæringen er tilgjengelig på følgende internettadresse:

Ελληνικά

Με το παρόν, η JVCKENWOOD δηλώνει ότι ο ραδιοεξοπλισμός DMX9724XDS συμμορφώνεται με την Οδηγία 2014/53/ΕΕ. Το πλήρες κείμενο της δήλωσης συμμόρφωσης της ΕΕ είναι διαθέσιμο στην ακόλουθη διεύθυνση στο διαδίκτυο:

Eesti

Käesolevaga JVCKENWOOD kinnitab, et DMX9724XDS raadiovarustus on vastavuses direktiiviga 2014/53/EL. Eli vastavusdeklaratsiooni terviktekst on kättesaadav järgmisel internetiaadressil:

Appendix

Latviešu

JVCKENWOOD ar šo deklarē, ka radio aparatūra DMX9724XDS atbilst direktīvas 2014/53/ES prasībām. Pilns ES atbilstības deklarācijas teksts ir pieejams šādā tīmekļa adresē:

Lietuviškai

Šiuo JVCKENWOOD pažymi, kad radijo įranga DMX9724XDS atitinka 2014/53/EB direktyvos reikalavimus. Visą EB direktyvos atitikties deklaracijos tekstą galite rasti šiuo internetiniu adresu:

Malti

B'dan, JVCKENWOOD jiddikjara li t-tagħmir tar-radjju DMX9724XDS huwa konformi mad-Direttiva 2014/53/UE. It-test kollu tad-dikjarazzjoni ta' konformità huwa disponibbli fl-indirizz intranet li ġej:

Українська

Таким чином, компанія JVCKENWOOD заявляє, що радіообладнання DMX9724XDS відповідає Директиві 2014/53/EU. Повний текст декларації про відповідність ЄС можна знайти в Інтернеті за такою адресою:

Türkçe

Burada, JVCKENWOOD DMX9724XDS radyo ekipmanının 2014/53/AB Direktifine uygun olduğunu bildirir. AB uyumluluk deklarasyonunun tam metni aşağıdaki internet adresinde mevcuttur.

Limba română

Prin prezenta, JVCKENWOOD declară că echipamentul radio DMX9724XDS este în conformitate cu Directiva 2014/53/UE. Textul integral al declarației de conformitate UE este disponibil la următoarea adresă de internet:

Български език

С настоящото JVCKENWOOD декларира, че радиооборудването на DMX9724XDS е в съответствие с Директива 2014/53/ЕС. Пълният текст на ЕС декларацията за съответствие е достъпен на следния интернет адрес:

URL : <https://www.kenwood.com/euukdoc/>



Declaration of Conformity with regard to the Radio Equipment Regulations 2017 (S.I. 2017/1206)

Declaration of Conformity with regard to the Restriction of the Use of Certain Hazardous Substances in Electrical and Electronic Equipment Regulations 2012 (S.I. 2012/3032)

Manufacturer:

JVCKENWOOD Corporation
3-12, Moriya-cho, Kanagawa-ku, Yokohama-shi,
Kanagawa, 221-0022, JAPAN

UK Importer:

JVCKENWOOD U.K. Limited
First Floor, Gleneagles, the Belfry, Colonial Way,
Watford, Hertfordshire WD24 4WH, UNITED
KINGDOM

Hereby, JVCKENWOOD declares that the radio equipment "DMX9724XDS" is in compliance with the relevant statutory requirements. The full text of the declaration of conformity is available at the following internet address: <https://www.kenwood.com/euukdoc/>

KENWOOD