



GENERAL

Frequency Range

Mode

Antenna Impedance

Voltage Requirements

Power Consumption

Backup current (Battery)

Semiconductor Complement

TRANSMITTER SECTION

RF Power Output

Modulation

Maximum frequency deviation

Carrier Suppression

Unwanted Emission Suppression

Spurious Radiation

Microphone Impedance

AF Response

Repeat

RTT

RECEIVER SECTION

Receiver

Intermod

Squish Sensitivity

Audio Output

Receiver Selectivity

# V-UHF ALL MODE DUO BANDER

## Model TS-780



### INSTRUCTION MANUAL

You are the owner of our latest product the new TS-780 Duo Band Transceiver. This unit has been carefully engineered and manufactured to rigid quality standards, and should give you satisfactory and dependable operation for many years. We suggest that you read this instruction manual carefully from cover to cover to insure the maximum performance and trouble-free operation of your new model TS-780. Save the shipping box and packing in the event your unit needs to be transported for remote operation, maintenance, or service.

## CONTENTS

SPECIFICATIONS .....	2
1. FEATURES .....	3
2. BEFORE USING .....	4
3. CONTROLS AND THEIR FUNCTIONS .....	5
4. PRELIMINARY .....	9
5. OPERATING INSTRUCTIONS .....	11
6. OPTIONAL ACCESSORIES .....	21
7. TROUBLESHOOTING .....	22
BLOCK DIAGRAM .....	23
SCHEMATIC DIAGRAM .....	24
TOP & BOTTOM INTERNAL VIEWS .....	27

# TS-780 SPECIFICATIONS

## GENERAL

Frequency Range .....	144.0 ~ 146.0 MHz 430.0 ~ 440.0 MHz
Mode .....	SSB (USB, LSB), CW, FM
Antenna impedance .....	50 $\Omega$ (144 MHz, 430 MHz)
Voltage Requirements .....	220 V AC, 50/60 Hz 13.8 V DC $\pm$ 15%
Power Consumption .....	Receive (no signal): 45 watts (220 V AC), 1.2 A (13.8 V DC) Transmit: 130 watts (220 V AC), 5 A (13.8 V DC)
Backup current (Battery) .....	Less than 10 $\mu$ A
Semiconductor Complement .....	Transistors: 149 FETs: 35 ICs: 41 Diodes: 195
Dimensions .....	290 (W) $\times$ 124 (H) $\times$ 322 (D) mm (11"-7/16) $\times$ (4"-7/8) $\times$ (12"-5/8)
Weight .....	10.1 kg (22.2 lbs)

## TRANSMITTER SECTION

RF Power Output .....	SSB, CW, FM: 10 watts FM (LOW): Approx. 1 watt
Modulation .....	SSB: Balanced modulation FM: Variable reactance frequency shift
Maximum frequency deviation (FM) .....	$\pm$ 5 kHz
Carrier Suppression .....	Better than 40 dB
Unwanted Sideband Suppression .....	Better than 40 dB
Spurious Radiation .....	Better than -60 dB
Microphone Impedance .....	500 ~ 600 $\Omega$
AF Response of Transmitter (SSB) .....	400 ~ 2600 Hz (-9 dB)
Repeater Frequency Shift .....	-600 kHz or +600 kHz (144.0 ~ 146.0 MHz) -7.6 MHz or -1.6 MHz (430.0 ~ 440.0 MHz)
RPT Tone Frequency .....	1750 Hz

## RECEIVER SECTION

Receiver Sensitivity .....	SSB, CW: 0.2 $\mu$ V for 10 dB (S+N)/N FM: 1 $\mu$ V for 30 dB (S+N)/N 0.2 $\mu$ V for 12 dB SINAD
Intermediate Frequency .....	1st: 30.865 MHz 2nd: 10.695 MHz 3rd: 455 kHz (FM only)
Squelch Sensitivity .....	0.16 $\mu$ V (At threshold)
Audio Output .....	2.0 watts (with less than 10% distortion) into an 8 ohm load
Receiver Selectivity .....	SSB, CW: 2.2 kHz (-6 dB) 4.8 kHz (-60 dB) FM: 14 kHz (-6 dB) 30 kHz (-60 dB)

Circuit and ratings are subject to change without notice for improvement.

# SECTION 1. FEATURES

1. 144/430 MHz, all mode (FM, SSB (USB, LSB), CW) transceiver.
  - 8 bit microprocessor controlled VFO and full variety of auxiliary functions.
  - FM circuitry based on KENWOOD's advanced technology and outstanding SSB quality.
  - Built-in VOX.
  - Built-in side tone and CW circuitry capable of semi-break-in operation.
  - Adoption of power module in the transmitter final stage for dependable operation on both bands.
2. Built-in digital display that indicates operating frequency in all modes.
  - Digital display equipped with easy-to-read green phosphor tubes.
  - 7-digit digital display that directly reads down to 100 Hz.
  - Frequency indicator that reads out carrier positions when mode of operation is changed.
  - Two VFO's (A and B) are built into the transmitter for more enjoyable operation such as "cross-frequency" operation.
  - Built-in 10-channel memory circuit stores operating frequencies and bands. Two channels (CH9 and CH10) can be called out by using CALL channel switch.
  - Easy-to-read display indicated 2 VFO's (A, B), memory channels (1 ~ 8) and priority channels (C and C').
  - Display function that clears frequency below 1 kHz in FM-CH.
3. Dependable electrical and mechanical functions
  - VFO frequencies are switchable in 2 speeds, SLOW (in 12.5 kHz, FM-CH) and FAST (in 5 kHz, FM-CH).
  - VFO knob equipped with variable torque mechanism.
  - Pushbutton band select switched (UP and DOWN) that shift up and shift down frequency between 144 MHz and 440 MHz in 12 bands at 1 MHz intervals.
  - Wide band design for both transmitter and receiver that eliminates the need for tuning the RF circuits.
  - Panel layout based on human engineering.
  - Full variety of indicating functions to check operating conditions (OFFSET, ON AIR, BUSY, F.LOCK, RIT, F.STEP).
  - Amplified type AGC and ALC circuits that maintain receive and transmit outputs at constant level without distortion.
4. A multitude of auxiliary functions for more enjoyable operation.
  - The use of RAM memory system enables any given frequencies to be stored in or cleared. (10 memory channels).
  - Built-in back-up battery holder to keep data stored at all times.
  - Built-in memory scan for selection between 144 MHz and 430 MHz.
  - RIT circuit function on VFO, memory channels and priority channels.
  - Adoption of frequency lock circuit.
  - A repeater shift circuit is provided, and the shift width on the 144 MHz band is - 600 kHz or + 600 kHz, and that on the 430 MHz band is - 7.6 MHz or - 1.6 MHz, which may be selected as required. The tone frequency is 1,750 kHz. In the event of off band, the digital display goes out and transmission is halted.
  - KENWOOD's unique noise blanker (NB) circuit to eliminate pulse type noise.
  - Four-function meter serves as S meter, RF meter, ALC meter and center meter.
  - RF power HIGH/LOW selecting function provides convenience in transmission with local stations in FM.
  - Auxiliary (AUX) socket.
5. Designed for fixed and mobile station services.
  - AC/DC 2-way power operation.
  - Equipped with a grip for carrying convenience.
  - Sufficient AF output power (2.5 W/4  $\Omega$ ).
  - Built-in large sized speaker (7.5 cm). External speaker connecting jack.

# SECTION 2. BEFORE USING

## 2-1. ACCESSORIES

The following accessory items are included with the unit.

Instruction manual .....	1 copy
Fuse 2A (AC) .....	2 pieces
7A (DC) .....	2 pieces
Foot (with screws) .....	2 pieces
Speaker plug .....	1 piece
DIN plug .....	1 piece
AC power cord .....	1 piece
DC power cord .....	1 piece
Microphone .....	1 piece

## 2-2. OPERATING LOCATION

As with any solid state equipment, the TS-780 should be kept from extremes of heat and humidity. Choose an operating location that is dry and cool, and avoid operating the unit in direct sunlight.

## 2-3. CABLING FOR ANTENNA, POWER SUPPLY AND OTHERS

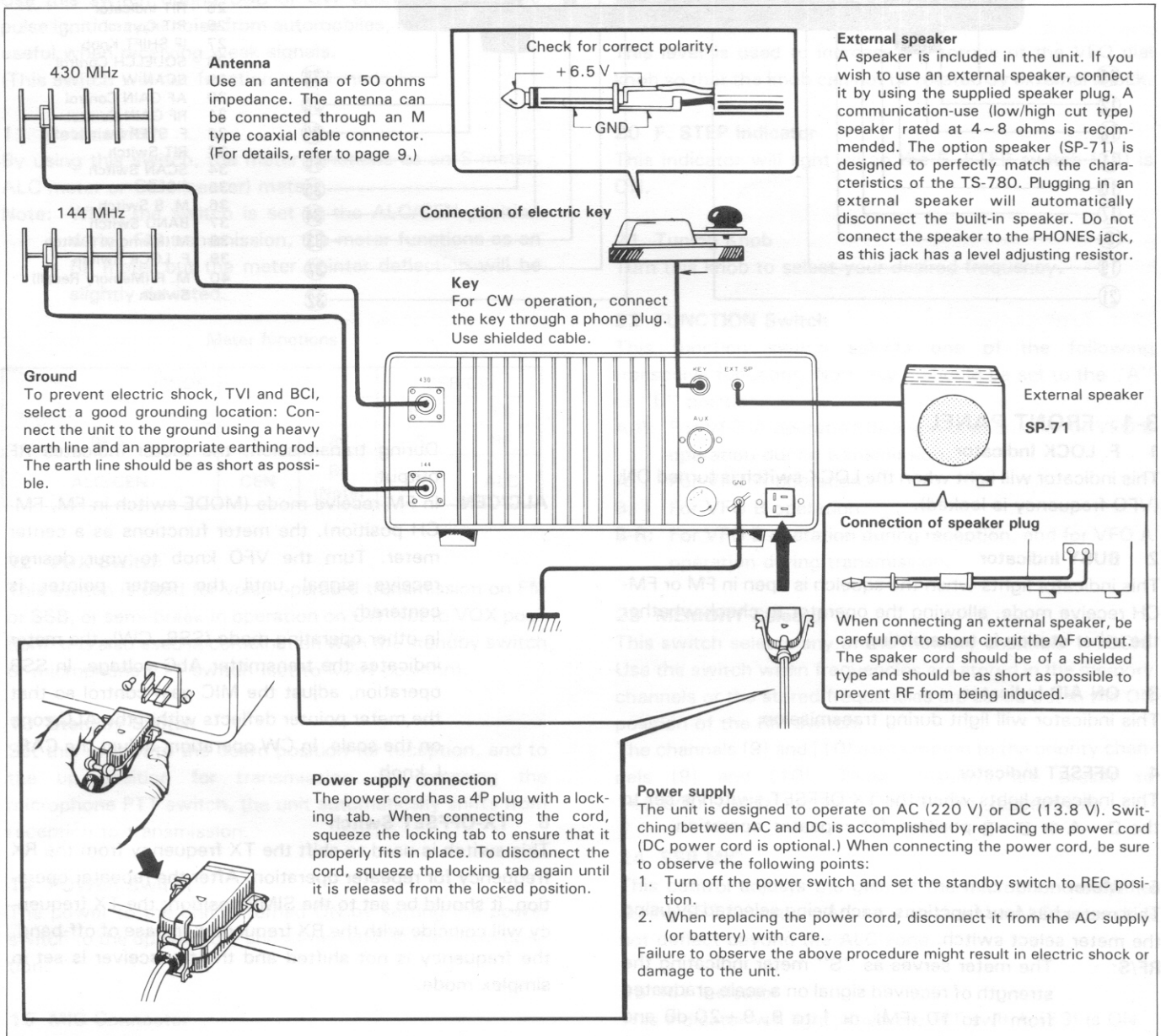

# SECTION 3. CONTROLS AND THEIR FUNCTIONS

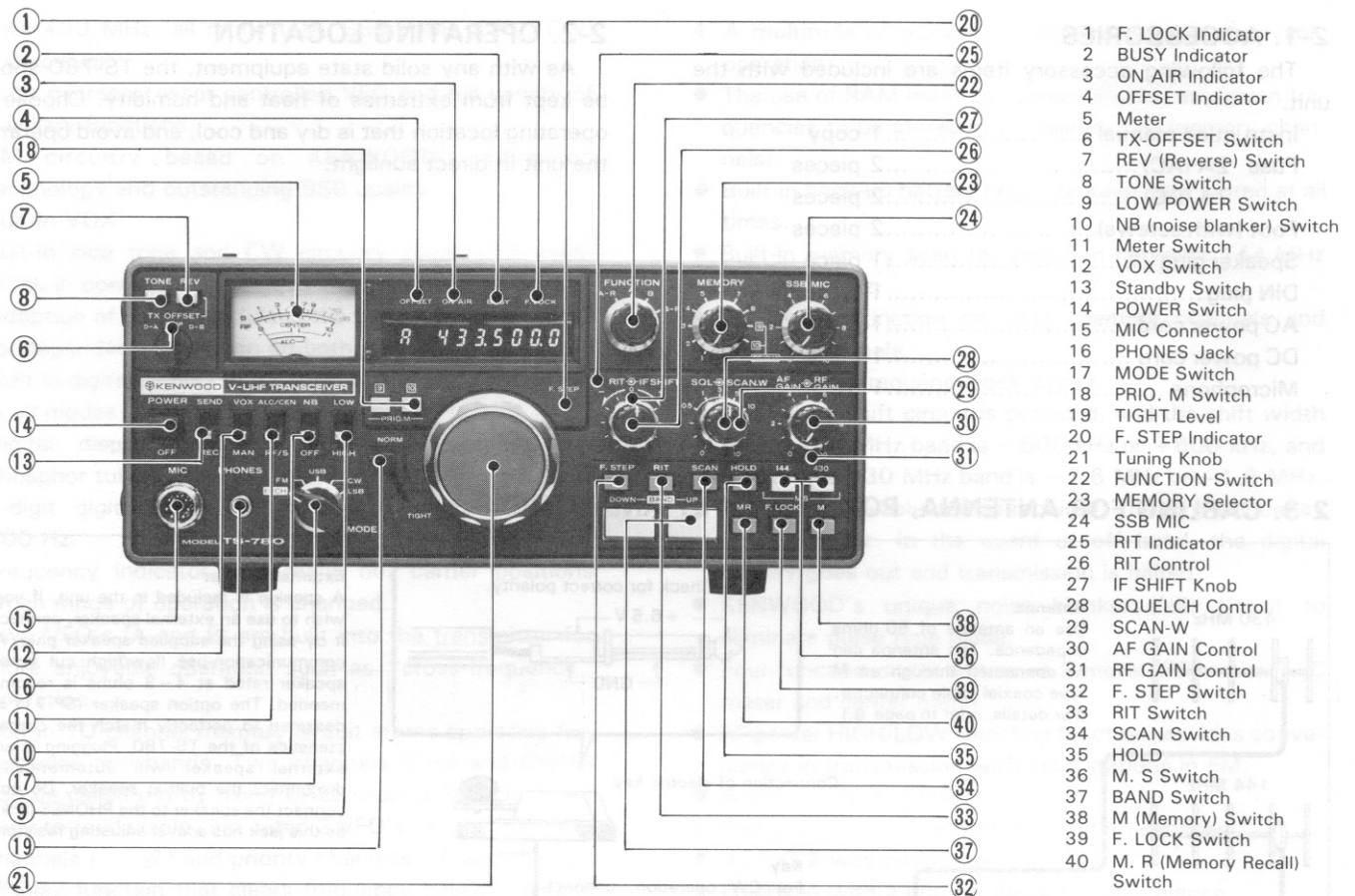

- 1 F. LOCK Indicator
- 2 BUSY Indicator
- 3 ON AIR Indicator
- 4 OFFSET Indicator
- 5 Meter
- 6 TX-OFFSET Switch
- 7 REV (Reverse) Switch
- 8 TONE Switch
- 9 LOW POWER Switch
- 10 NB (noise blanker) Switch
- 11 Meter Switch
- 12 VOX Switch
- 13 Standby Switch
- 14 POWER Switch
- 15 MIC Connector
- 16 PHONES Jack
- 17 MODE Switch
- 18 PRIO. M Switch
- 19 TIGHT Level
- 20 F. STEP Indicator
- 21 Tuning Knob
- 22 FUNCTION Switch
- 23 MEMORY Selector
- 24 SSB MIC
- 25 RIT Indicator
- 26 RIT Control
- 27 IF SHIFT Knob
- 28 SQUELCH Control
- 29 SCAN-W
- 30 AF GAIN Control
- 31 RF GAIN Control
- 32 F. STEP Switch
- 33 RIT Switch
- 34 SCAN Switch
- 35 HOLD
- 36 M. S Switch
- 37 BAND Switch
- 38 M (Memory) Switch
- 39 F. LOCK Switch
- 40 M. R (Memory Recall) Switch

## 3-1. FRONT PANEL

### 1 F. LOCK Indicator

This indicator will light when the LOCK switch is turned ON (VFO frequency is locked).

### 2 BUSY Indicator

This indicator lights when the squelch is open in FM or FM-CH receive mode, allowing the operator to check whether the other station is transmitting.

### 3 ON AIR Indicator

This indicator will light during transmission.

### 4 OFFSET Indicator

This indicator lights when the TX OFFSET switch is set to the D - A or D - B position for repeater operation.

### 5 Meter

This meter has four functions, each being selected by using the meter select switch.

**RF/S:** The meter serves as "S" meter indicating the strength of received signal on a scale graduated from 1 to 10 (FM), or 1 to 9, 9 + 20 dB and 9 + 40 dB (SSB, CW).

During transmission, the meter indicates RF output.

**ALC/CEN:** In FM receive mode (MODE switch in FM, FM-CH position), the meter functions as a center meter. Turn the VFO knob to your desired receive signal until the meter pointer is centered.

In other operating mode (SSB, CW), the meter indicates the transmitter ALC voltage. In SSB operation, adjust the MIC gain control so that the meter pointer deflects within the ALC zone on the scale. In CW operation, adjust the CAR. L knob.

### 6 TX-OFFSET Switch

This switch is used to shift the TX frequency from the RX frequency for repeater operation. After the repeater operation, it should be set to the SIMP position; the TX frequency will coincide with the RX frequency. In case of off-band, the frequency is not shifted and the transceiver is set in simplex mode.

### 7 REV (Reverse) Switch

This switch is used to check repeater input signal. By depressing the switch, the TX and RX frequencies are reversed. To reverse the frequencies once again, set the transceiver in transmit mode while holding the switch in the depressed position.

### 8 TONE Switch

Tone oscillator switch which makes 1750 Hz FM wave when pressed in FM mode only.

### 9 LOW POWER Switch

Set this switch to LOW position and the FM transmit output is reduced to about 1 watt. Use the switch for FM mode only. (This switch has no effect on SSB and CW mode.)

### 10 NB (noise blanker) Switch

Use this switch during SSB or CW operation to reduce pulse ignition type noise from automobiles, etc. This is very useful when receiving weak signals.

(This switch will not function in FM mode.)

### 11 Meter switch

By using this switch, the meter functions as an S meter, ALC meter or CEN (center) meter.

**Note:** When the switch is set to the ALC/CEN position during FM transmission, the meter functions as an RF meter but the meter pointer deflection will be slightly deviated.

Meter functions

Switch \ MODE	FM		SSB/CW	
	RX	TX	RX	TX
RF/S	S	RF	S	RF
ALC/CEN	CEN	RF (Note)	S	ALC

### 12 VOX Switch

This switch is used for voice operated transmission on FM or SSB, or semi-break-in operation on CW (set to VOX position). It is also used in combination with the standby switch or microphone PTT switch (set to MAN position).

### 13 Standby Switch

Set this switch to the down position for reception, and to the up position for transmission. By pressing the microphone PTT switch, the unit automatically shifts from reception to transmission.

### 14 POWER Switch

The power to the unit is turned ON by setting the power switch to the up position, and turned OFF at the down position.

### 15 MIC Connector

Connector for microphone up/down input and PTT circuit.

### 16 PHONES Jack

This headphone jack allows use of a set of headphones of 8-16 ohms impedance. Connect KENWOOD headphones HS-4, 5 or 6 available as an optional accessory. A stereo headphones may also be connected.

### 17 MODE Switch

In FM-CH mode, the VFO frequency is switched in 20/10 kHz steps.

In FM, LSB, USB or CW mode, the VFO frequency is switched in 20/200 Hz steps.

### 18 PRIO. M Switch

Depress the PRIO. M [9] switch to call out the memory channel 9CH. Depress the [10] switch to call out the 10CH. These memory channels are preset to 145.000.0 and 433.000.0, respectively, but can be set to any desired frequencies.

### 19 TIGHT lever

This lever is used to increase the torque of the VFO dial knob so that the knob can not be rotated by external shock.

### 20 F. STEP Indicator

This indicator will light when the F. STEP switch (32) is ON.

### 21 Tuning Knob

Turn this knob to select your desired frequency.

### 22 FUNCTION Switch

This function switch selects one of the following transceiver functions. Normally it should be set to the "A" or "B" position.

**A-R:** For VFO A operation during reception and for VFO B operation during transmission.

**A:** For VFO A operation.

**B:** For VFO B operation.

**B-R:** For VFO B operation during reception, and for VFO A operation during transmission.

### 23 MEMORY Selector

This switch selects any of the memory channels 1-10CH. Use the switch when frequencies are stored in the memory channels or the stored frequencies are called out in the ON position of the RM switch.

The channels [9] and [10] are common to the priority channels [9] and [10]. These channels are preset to 145.000.0 MHz and 433.000.0 MHz, respectively.

### 24 SSB MIC

This control adjusts the gain of the microphone amplifier during SSB operation. Adjust it so that the ALC meter does not deflect beyond the ALC zone.

### 25 RIT Indicator

This indicator will light when the RIT switch (33) is ON.

## SECTION 3 CONTROLS AND THEIR FUNCTIONS

### 26 RIT Control

With the RIT switch ON, the RIT knob allows the operator to vary the receive frequency by about  $\pm 1.5$  kHz without affecting the transmit frequency. The center position "0" is RIT-OFF.

### 27 IF SHIFT Knob

By using this control, the IF crystal filter center frequency can be shifted  $\pm 1$  kHz, allowing adjustment of tone quality, or eliminating interference from adjacent frequencies. For normal operation, this control should be set to the center "0" position (detent).

### 28 SQUELCH Control

Turning this control clockwise during FM mode will activate the squelch circuit.

### 29 SCAN-W

This switch is used to select the scan width (0.5, 1, 3, 5 and 10 MHz).

### 30 AF GAIN Control

This control adjusts the gain of the receiver audio amplifier. Clockwise rotation will increase the output level.

### 31 RF GAIN Control

For adjusting the RF amplifier gain of the receiver. The gain is minimum at the extreme counterclockwise position. Normally, this control is set in its extreme clockwise position.

### 32 F. STEP Switch

By using this switch, the VFO frequency is varied at a slow or fast speed as shown below. The operating conditions can be checked on the F. STEP indicator.

F. STEP

Mode	F. STEP switch	
	OFF	ON
SSB-CW-FM	20 Hz	200 Hz
FM - CH	12.5 kHz	5 kHz

### 33 RIT Switch

This push switch turns the RIT (Receiver Increment Tuning) circuit ON and OFF. With the switch depressed, the circuit is activated and the RIT indicator is illuminated. The RIT circuit is turned OFF when the switch is out.

### 34 SCAN Switch

This switch turns ON and OFF the VFO scan circuit. The VFO frequency is scanned at the speed selected by the F. STEP switch. The switch is also used for re-scanning of M. S (memory scan) or for scanning at busy stop.

### 35 HOLD

This switch is used to stop scan operation.

### 36 M. S Switch

This switch selects and scans the frequency stored in the memory channel. Scan is released by the HOLD switch or by setting the transceiver in transmit mode.

### 37 BAND Switch

For selecting the band (144-145 MHz or 430-439 MHz) to be operated. By pressing the UP switch, the frequency is stepped up band by band. When the DOWN switch is pressed, the frequency is stepped down band by band. In either case, the band is switched in 1 MHz steps.

### 38 M (Memory) Switch

This switch is used to store the desired frequency in the memory channel.

When the switch is depressed, an oscillation sound is heard, indicating that the frequency is stored in the memory channel.

### 39 F. LOCK Switch

This switch locks the operating frequency of VFO. With the switch ON, the VFO frequency remains unchanged even when the tuning knob, BAND switch or MIC UP/DOWN switch is manipulated. This feature is useful when operating the transceiver on the same frequency for many hours, or when it is used for mobile operation.

The RIT switch can be used even in the ON position of the F. LOCK switch. The F. LOCK indicator will light when the F. LOCK switch is ON.

### 40 M. R (Memory Recall) Switch

Memory channel is called out when this switch is turned ON. For the channels in which frequencies are not stored, the corresponding channel numbers are indicated.

## 3-2. REAR PANEL

### 1 430 MHz ANT (antenna) Connector (N type)

For connection of the 430 MHz band antenna.

### 2 144 MHz ANT (antenna) Connector (M type)

For connection of the 144 MHz band antenna.

### 3 Heat Sink

Dissipates heat from the final stage transistors and power supply transistors.

### 4 CW KEY Jack

This jack is used for operating the transceiver in CW mode. Connect a telegraph key using a 2P plug.

### 5 SP (External Speaker) Jack

Connect an external speaker of 4-8 ohms impedance using the supplied plug.



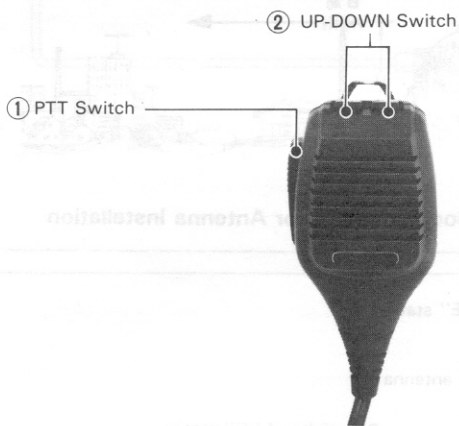
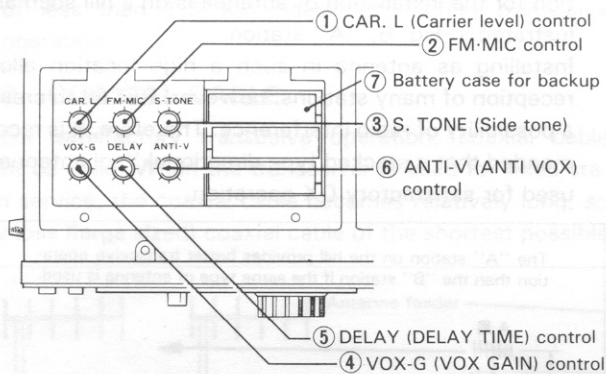
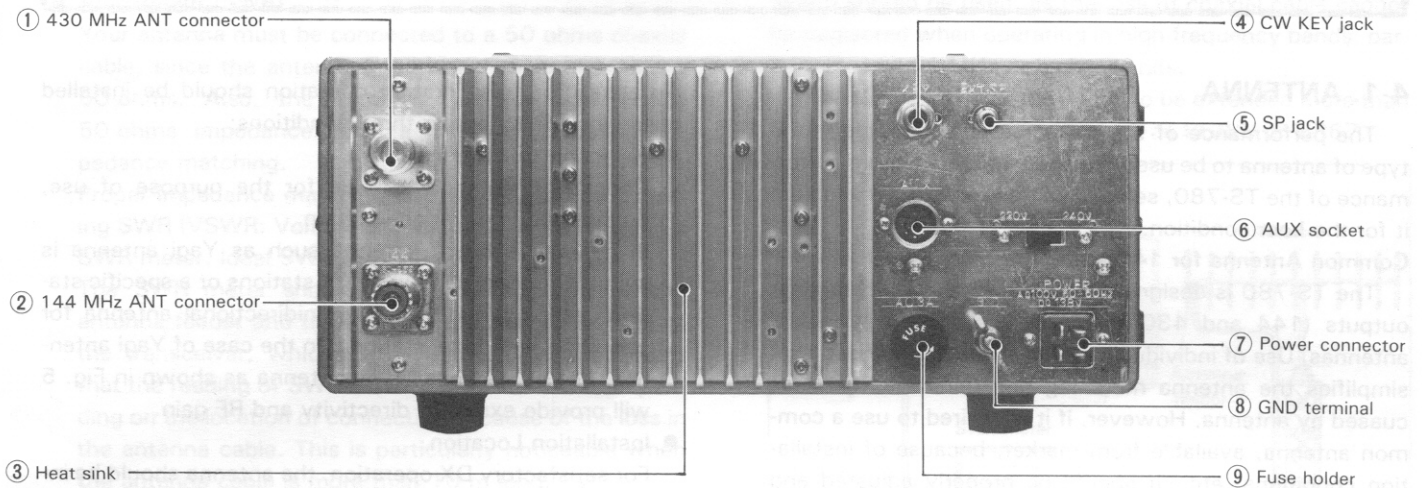

**6 AUX socket**

This connector is used for controlling a linear amplifier, etc., or for external standby. For connection, use the supplied 7P plug (DIN type).

**7 Power Connector (AC and DC)**

For connection of the supplied AC power cord or the specified DC power cord (DC 13.8 V).

**8 GND (earth) Terminal**

For connection of an earth lead.

**9 Fuse Holder**

A 2A fuse. When it blows, check the cause and replace with the spare supplied.

**3-3. INTERNAL VIEW**

**1 CAR. L (Carrier Level) Control**

This control adjusts the carrier level in CW mode. It does not function in other modes. Use the control within the ALC zone.

**2 FM-MIC Control**

This control adjusts the sensitivity of the microphone during FM transmission.

**3 SIDE TONE Control**

This control adjusts the monitoring level of side tone during CW operation.

**4 VOX-G Control**

This control adjusts the sensitivity of the VOX controlled operation.

**5 DELAY (Delay Time) Control**

This control adjusts the VOX time constant. Adjust it according to the speed of speech.

**6 ANTI-V (ANTI VOX) Control**

This control is used to adjust the VOX system so that it is not tripped by sound from the speaker.

**7 Back-up Battery Case**

Load battery into the case to back-up memory channels. Battery will last for about 1 year.

**3-4 MICROPHONE**

**1 PTT Switch**

Press-to-talk switch for transmission.

**2 UP-DOWN Switch**

This switch is used to shift the VFO frequency up or down.

# SECTION 4. PRELIMINARY

## 4-1. ANTENNA

The performance of the transceiver depends upon the type of antenna to be used. To ensure the maximum performance of the TS-780, select a suitable antenna and adjust it for the best condition.

### Common Antenna for 144/430 MHz Operation

The TS-780 is designed so that two different transmit outputs (144 and 430 MHz) are supplied to individual antennas. Use of individual antennas is recommended as it simplifies the antenna matching and minimizes the loss caused by antenna. However, if it is desired to use a common antenna, available from market, because of installation conditions, etc., it should be properly adjusted and connected by carefully following the instruction manual furnished with the antenna. An example of connection of a common antenna is illustrated in Fig. 4.

#### Notes:

1. A common antenna should be connected through a dividing filter (some types of common antenna have built-in dividing filter).
2. An antenna selector (up to 430 MHz) may be used in lieu of a dividing filter.
3. Never attempt to connect a common antenna without using a dividing filter.

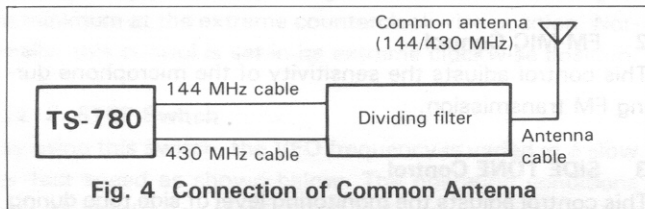

#### Type of Antenna

Choose a proper antenna according to whether it is used for fixed station or mobile station operation. For fixed station operation, a Yagi antenna (directional type) or a ground plane antenna (omnidirectional type) is recommended.

Antennas for fixed station operation should be installed observing the following three conditions:

#### ● Selection of Antenna

Choose an antenna suitable for the purpose of use, budget and installation location.

In general, a beam antenna such as Yagi antenna is suitable for operation with DX stations or a specific station, and a ground plane omnidirectional antenna for operation with local stations. In the case of Yagi antennas, use of a stacked type antenna as shown in Fig. 5 will provide excellent directivity and RF gain.

#### ● Installation Location

For satisfactory DX operation, the antenna should be installed as high as possible. An example of a good location for the installation of antenna is on a hill such as illustrated in Fig. 6, "A" station.

Installing an antenna in such a high location allows reception of many stations; however, this often creates a possibility of radio interference. Therefore, it is recommended that a stacked type directional Yagi antenna be used for satisfactory DX operation.

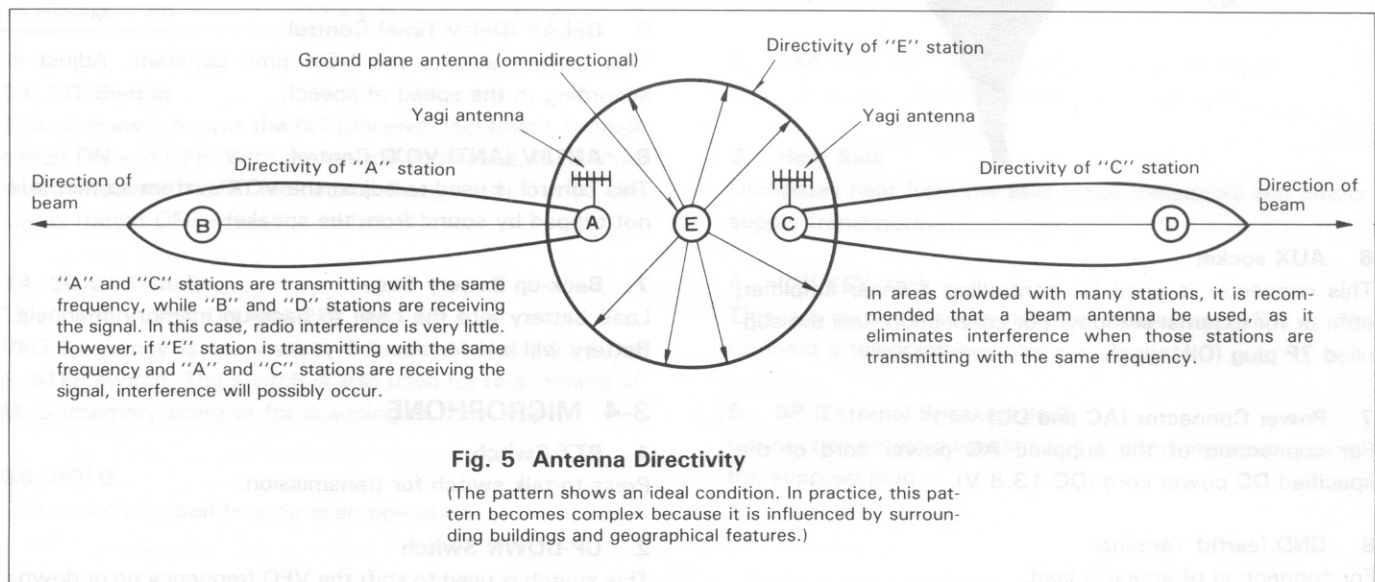
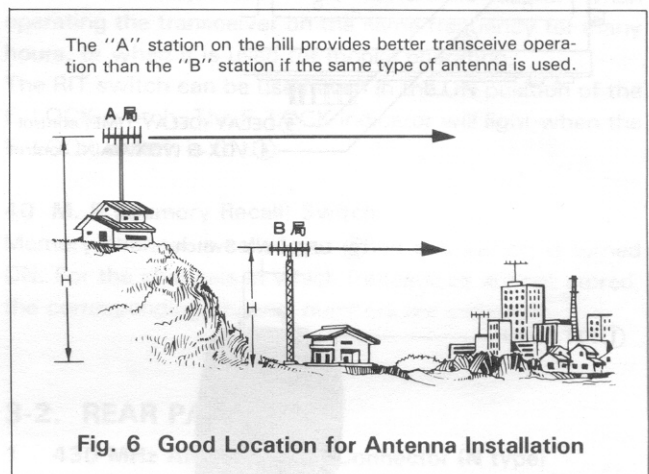

● Adjustment (SWR)

Your antenna must be connected to a 50 ohms coaxial cable, since the antenna impedance of the TS-780 is 50 ohms. Also, the antenna must be adjusted to 50 ohms impedance. This adjustment is called impedance matching.

Proper impedance matching is accomplished by checking SWR (VSWR: Voltage Standing Wave Ratio) using a SWR meter. Ideal SWR is 1:1.

The SWR meter should be connected between the antenna feeder and the antenna terminal at the rear of the transceiver, whichever is more convenient. Note that the reading of SWR meter varies somewhat depending on the location of connection because of the loss in the antenna cable. This is particularly noticeable when the antenna cable is more than 10 m long.

An antenna system which shows a standing wave ratio of less than 1.5 will insure satisfactory transceiver operation.

**4-2. COAXIAL CABLE**

For satisfactory transceiver operation, coaxial cable must be used. When the transceiver is used for fixed station service, the coaxial cable becomes relatively long, so low loss (large sized) coaxial cable of the shortest possible

length should be used, as the loss of coaxial cable cannot be neglected when operating in high frequency bands, particularly in 144 MHz or higher bands.

When the coaxial cable needs to be extended more than 10 m, use one of larger size such as RG8/U or UR67.

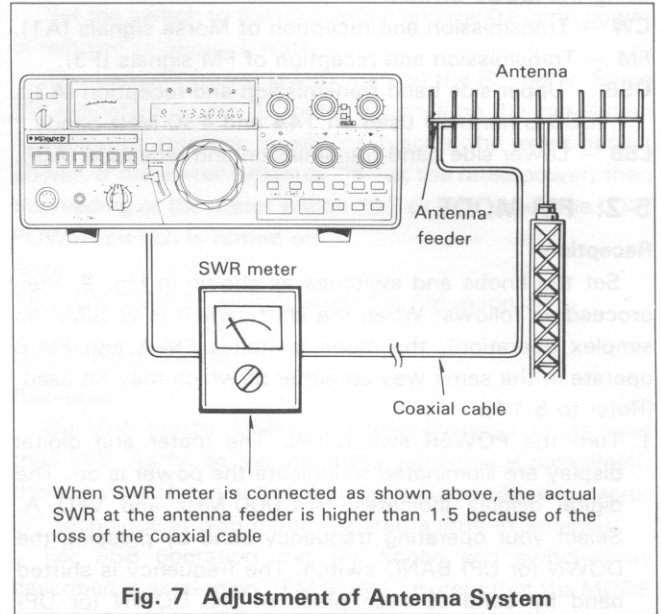

**Fig. 7 Adjustment of Antenna System**

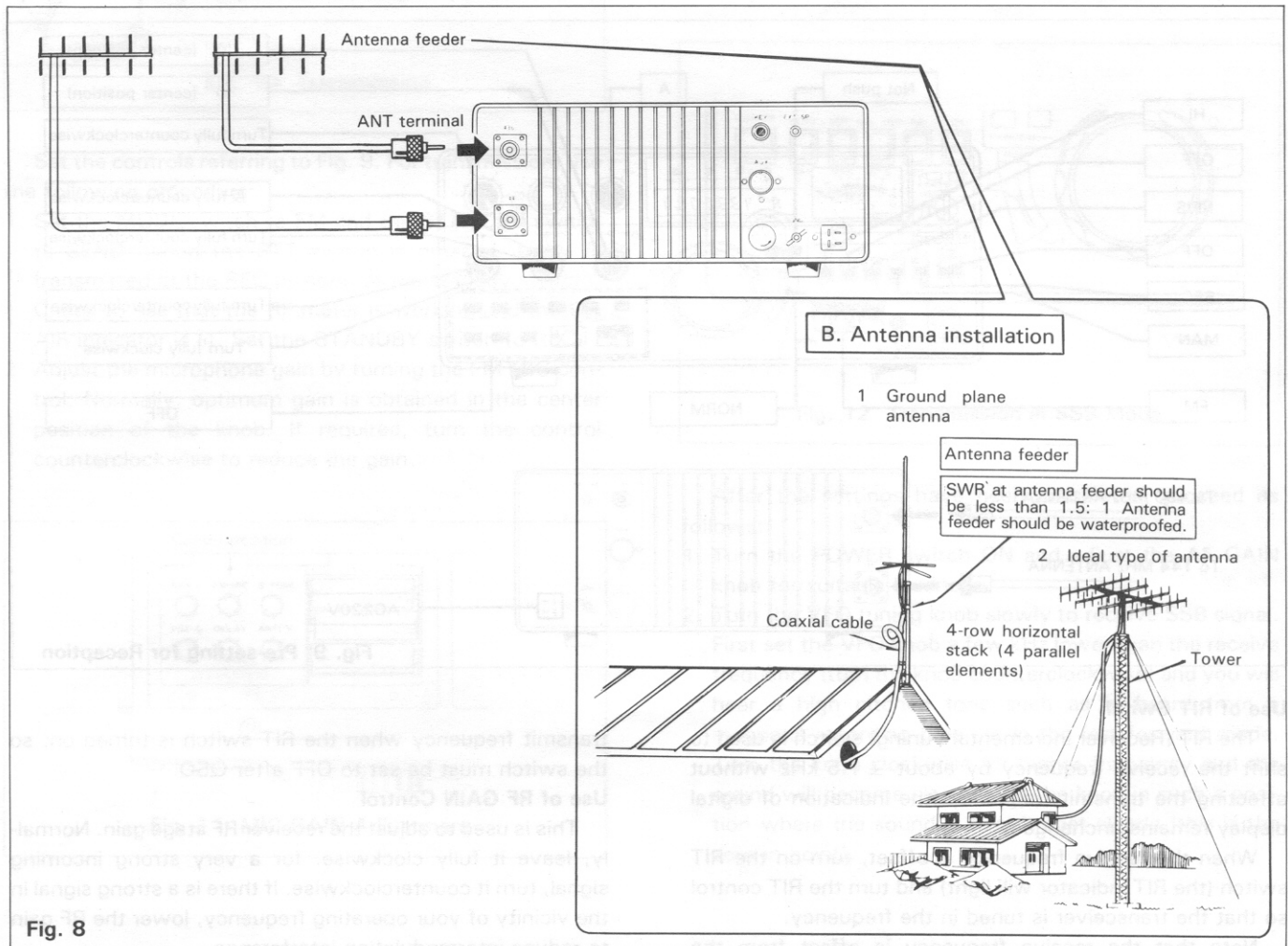

**Fig. 8**

# SECTION 5. OPERATING INSTRUCTIONS

## 5-1. OPERATING MODES

The TS-780 can be operated in the following modes by using the MODE switch.

- CW** — Transmission and reception of Morse signals (A1).
- FM** — Transmission and reception of FM signals (F3).
- USB** — Upper side band transmission and reception (A3j).  
USB is normally used on 144 and 430 MHz bands.
- LSB** — Lower side band transmission and reception (A3j).

## 5-2. FM MODE

### Reception

Set the knobs and switches as shown in Fig. 9, then proceed as follows: When the shift switch is at SIMP (in simplex operation), the mode switches FM-A and FM-B operate in the same way so either of which may be used. (Refer to 5-14).

1. Turn the POWER switch ON. The meter and digital display are illuminated to indicate the power is on. The digital display indicates 144.000 MHz and VFO A. Select your operating frequency band by pressing the DOWN (or UP) BAND switch. The frequency is shifted band by band at each press of the DOWN (or UP)

switch. When either switch is pressed for 0.5 second or longer, the frequency is shifted about 0.5 second intervals.

2. Turn the AF GAIN control clockwise and noise or signal will be heard from the speaker. Adjust the control for suitable level.  
(To eliminate the noise which is heard when signal is absent, turn the SQL control.)
3. Turn the VFO dial slowly until the signal is heard most clearly while observing the "S" meter deflection.
4. Set the meter switch to ALC/CEN and turn the VFO dial until the meter is centered while receiving the signal of the other station. When the meter pointer indicates the center position, it means that the transmit frequency has tuned to the receive frequency. Set the meter switch to RF/S. Since the IF band is wide in FM mode, a slight deviation of frequency does not affect the reception. In transmitting operation, however, the other party may be using a fixed channel, so it is advisable to set the meter in the center position (zero-in) by adjusting the VFO dial knob.

\* Zero-in means that your transmit frequency coincides precisely with the receive frequency.

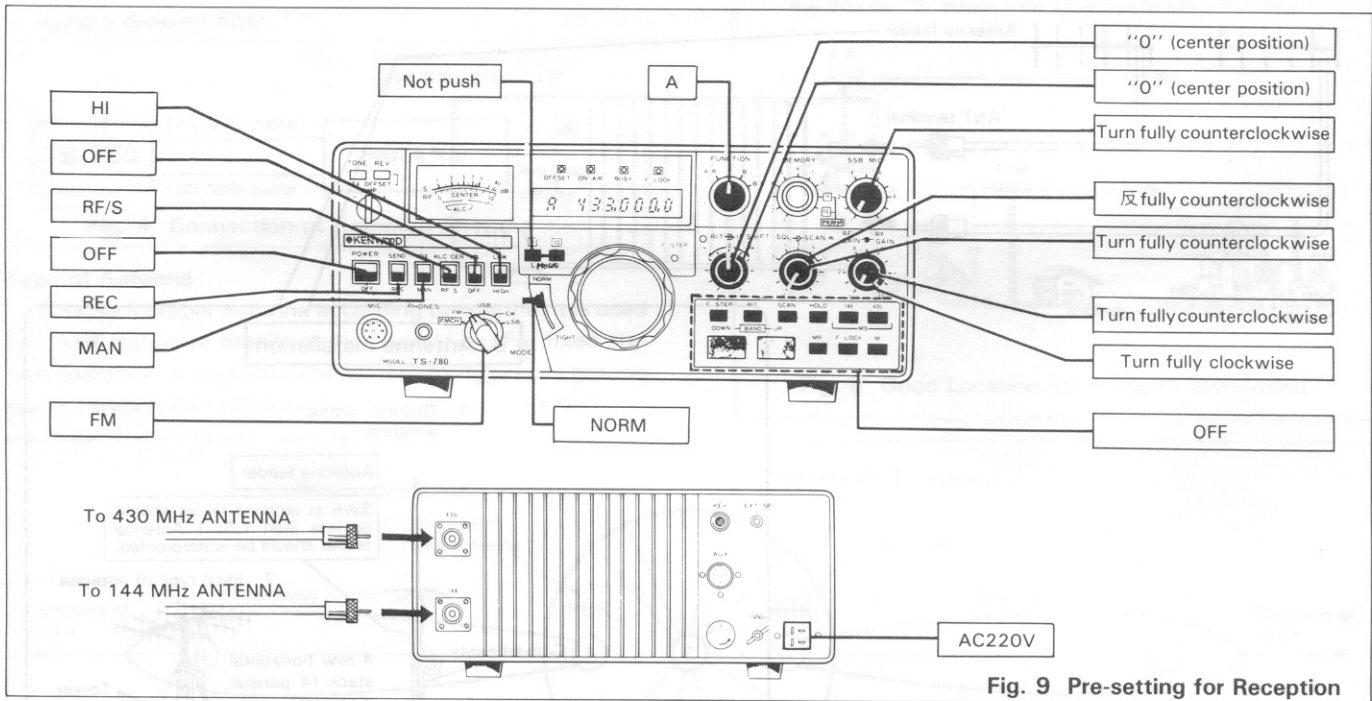

Fig. 9 Pre-setting for Reception

### Use of RIT Switch

The RIT (Receiver incremental Tuning) switch is used to shift the receive frequency by about  $\pm 1.5$  kHz without affecting the transmit frequency (the indication of digital display remains unchanged).

When the receive frequency is offset, turn on the RIT switch (the RIT indicator will light) and turn the RIT control so that the transceiver is tuned in the frequency.

Note that the receive frequency is offset from the

transmit frequency when the RIT switch is turned on, so the switch must be set to OFF after QSO.

### Use of RF GAIN Control

This is used to adjust the receiver RF stage gain. Normally, leave it fully clockwise. for a very strong incoming signal, turn it counterclockwise. If there is a strong signal in the vicinity of your operating frequency, lower the RF gain to reduce intermodulation interference.

### Use of SQUELCH control

This control is used to eliminate noise when signal is absent. Turn the control slowly until noise disappears. When the control is properly adjusted, only the receive signal is heard from the speaker. This control is also used according to the strength of input signal during mobile operation.

### Transmission

#### Notes:

1. Before transmitting, perform all the necessary procedures for optimum reception. Make sure that the frequency you have selected does not interfere with other stations.
2. Check to make sure that the antenna connected is of the proper type. Use of an improper antenna will result not only in insufficient power but also in TV1 and BC1. Do not attempt to operate the transceiver without connecting antenna as it will cause damage to the transceiver.

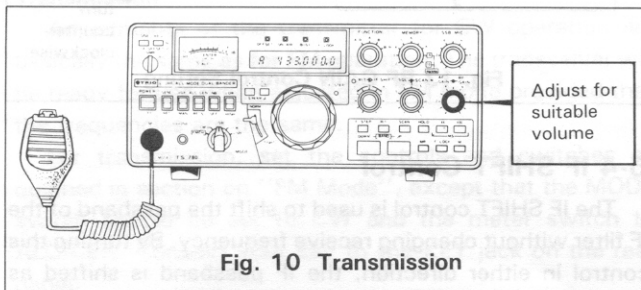

Fig. 10 Transmission

Set the controls referring to Fig. 9. For transmission, use the following procedure:

1. Set the MODE switch to FM and the STANDBY switch to SEND (when the PTT switch is pressed, signal is transmitted at the REC position of the standby switch). Check to see that the RF meter is working and the ON AIR indicator is lit. Set the STANDBY switch to REC.
2. Adjust the microphone gain by turning the FM MIC control. Normally, optimum gain is obtained in the center position of the knob. If required, turn the control counterclockwise to reduce the gain.

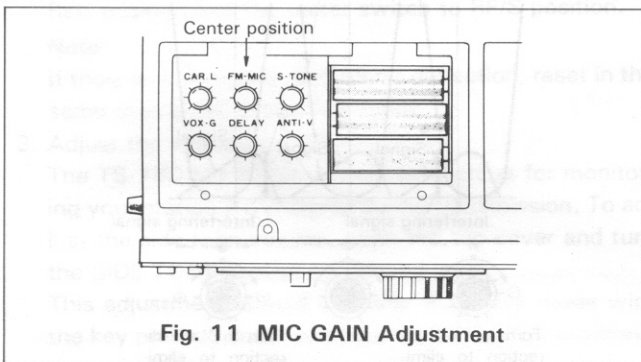

Fig. 11 MIC GAIN Adjustment

### Use of LOW POWER Switch

This switch is used to reduce transmit power during operation with a local station, thus preventing interference to other stations. It is also effective to reduce the power consumption.

Set the switch to the up position and the transmit power is reduced to about 1 watt.

The transmit power is indicated on the RF meter. Since the indication on the RF meter depends on the installation condition of antenna, it will not indicate the exact output power. If the meter indicates "8" at the rated power, then the reading of the meter will be "1" or "2" when the LOW POWER switch is turned on.

#### Note:

The LOW POWER switch is used in FM mode only.

### 5-3. SSB Mode

#### Reception

On VHF bands, USB is traditionally more often used than LSB. As far as the operating technique is concerned, there is no difference between two. Generally, the "zero-in" technique in SSB mode required a little experience.

For SSB operation, set the knobs and switches as described in section on "FM Mode", except that the MODE switch should in USB position.

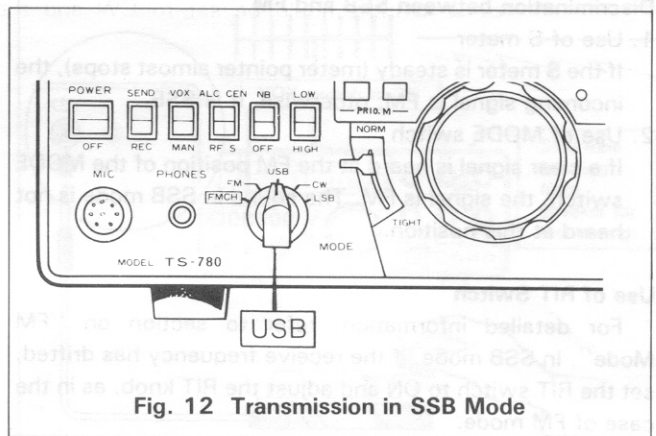

Fig. 12 Transmission in SSB Mode

After the settings have been completed, proceed as follows:

1. Turn the POWER switch ON and adjust the AF GAIN knob for suitable loudness.
2. Turn the VFO tuning knob slowly to receive SSB signal. First set the VFO knob a few kHz lower than the receive frequency (turn the USB counterclockwise) and you will hear a high pitched tone such as is heard from a magnetic recording tape set in the fast-forward mode. Turn the knob clockwise for higher frequency and the sound will become clearer. Set the knob in such a position where the sound is heard most clearly (this is the zero-in point).

**Note:**

The zero-in point can be easily located because the sound loses its clarity suddenly when the frequency passes away from the zero-in point. If a clear sound cannot be heard by following the above procedure, it may be an indication that the signal is LSB. Set the MODE switch to LSB position. In this case, the setting of the VFO knob should be made in reverse order.

**Transmission**

1. Set the MODE switch to USB and the meter switch to ALC/CEN. Other controls remain the same as outlined in section on "FM Mode".
2. Adjust the microphone gain. This adjustment should be made with the standby switch set to SEND or the microphone PTT switch depressed. Next, speak into the microphone and adjust the SSB MIC gain control on the front panel, making sure that the ALC meter does not deflect beyond the ALC zone. After completion of the above adjustment, set the meter switch to RF.

**Note:**

Periodically check the ALC meter deflection. If, due to heat, etc., there is a change in deflection, reset the meter to within the ALC zone.

**Discrimination between SSB and FM**

1. Use of S meter  
If the S meter is steady (meter pointer almost stops), the incoming signal is FM; otherwise, it is SSB.
2. Use of MODE switch  
If a clear signal is heard at the FM position of the MODE switch, the signal is FM. The sound in SSB mode is not heard at this position.

**Use of RIT Switch**

For detailed information, refer to section on "FM Mode". In SSB mode, if the receive frequency has drifted, set the RIT switch to ON and adjust the RIT knob, as in the case of FM mode.

When the RIT switch is ON, the receive frequency is offset from the transmit frequency, so it is necessary to turn the switch off when tuning to another frequency.

**Use of NB (noise blanker) Switch**

The NB switch is used to suppress pulse noise such as ignition noise generated by car engine.

**Use of RF GAIN Control**

For detailed information, refer to section on "FM Mode". Normally, this control should be left in full clockwise position. When a very strong incoming signal is present, turn it counterclockwise. The noise level below the receive signal level is attenuated for clear reception.

If the RF GAIN is reduced excessively in SSB or CW mode, the S meter deflection will increase irrespective of incoming signal strength. This is due to the circuit characteristics and is not an indication of trouble.

The secret of reading accurate signal strength is to turn the RF GAIN control counterclockwise so that it is a little lower than the signal level read on the S meter at the full clockwise position, as shown in Fig. 13.

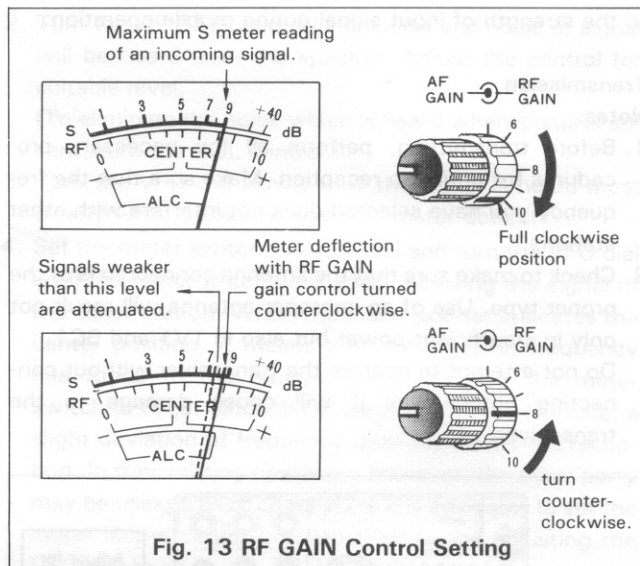

**5-4 IF SHIFT Control**

The IF SHIFT control is used to shift the passband of the IF filter without changing receive frequency. By turning this control in either direction, the IF passband is shifted as shown in Fig. 14.

The IF SHIFT is effective in eliminating interference when the receive signal is superimposed on nearby signals during operation in both SSB and CW modes.

Turning the control in "+" direction will eliminate interference from low frequency signal. In this way, the low frequency component in the signal is cut off.

Turning the control in "-" direction will eliminate interference from high frequency signal. The high frequency component is cut off accordingly.

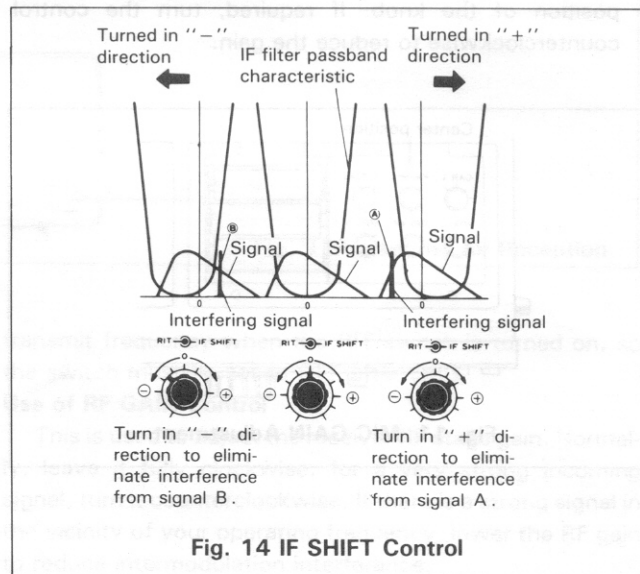

## 5-5 CW Mode

### Reception

Set the controls and switches as outlined in section on "FM Mode", except that the MODE switch should be set to CW. For reception, proceed as follows:

1. Turn the POWER switch ON and adjust the AF GAIN control for suitable volume.
2. Turn the VFO knob slowly for the desired receive signal so that a 800 Hz beat is heard. In this way, the frequency of your station will coincide (zero-in) with the frequency of your party's station.

Similarly, if your party calls back with a 800 Hz beat in response to your call, it means that the party's frequency has coincided with your frequency.

### Note:

The 800 Hz beat can be checked by using a frequency counter.

### Transmission

Adjustments of the transmitter for CW operation are basically the same as for FM operation. The transceiver will be ready for use when adjusted in FM mode provided that the frequencies are the same.

For transmission, set the controls and switches as outlined in section on "FM Mode", except that the MODE switch should be set to CW and the meter switch to ALC/CEN. Connect your key to the KEY jack on the rear panel.

1. Check to ensure that the MODE switch is set to CW. Set the standby switch to SEND and the ON AIR indicator will light. Under this condition, press the key down and the ALC meter should deflect. Set the standby switch back to REC position.

### Note:

If the key is not connected, the ALC meter will deflect when the standby switch is set to SEND.

2. Adjust the CAR LEVEL control  
With the standby switch in the SEND position, adjust the control so that the ALC meter deflects within the ALC zone when the key is pressed down. Then, release the key. Set the standby switch back to REC position and the meter switch to RF/S position.

### Note:

If there is a change in ALC meter deflection, reset in the same manner as in the SSB mode.

3. Adjust the side tone  
The TS-780 has a built-in side tone circuit for monitoring your station's CW signal during transmission. To adjust the side tone volume, open the top cover and turn the SIDE TONE control for desired level.

This adjustment should be made in receive mode with the key pressed down (standby switch in REC position), since, in so doing, the side tone circuit is activated.

### Use of RIT Switch

For detailed information, refer to section on "FM Mode". Use the RIT switch when your party's frequency has deviated from 800 Hz or you wish to transmit with a different beat frequency.

### Use of NB Switch

Refer to section on "SSB Mode".

### Use of RF GAIN Knob

Refer to section on "SSB Mode".

### Use of IF SHIFT Control

By using the IF SHIFT in conjunction with the RIT, tone quality can be adjusted.

### Semi-Break-In Operation

The TS-780 is capable of semi-break-in operation, in addition to the usual CW operation with the standby switch. The semi-break-in uses the side tone to activate the VOX circuit which switches to transmit when the key is pressed down and to receive when it is released. For semi-break-in operation, set the MODE switch to CW and the VOX switch to ON. Other operating procedures are the same as for the usual VOX operation (Refer to 5-6).

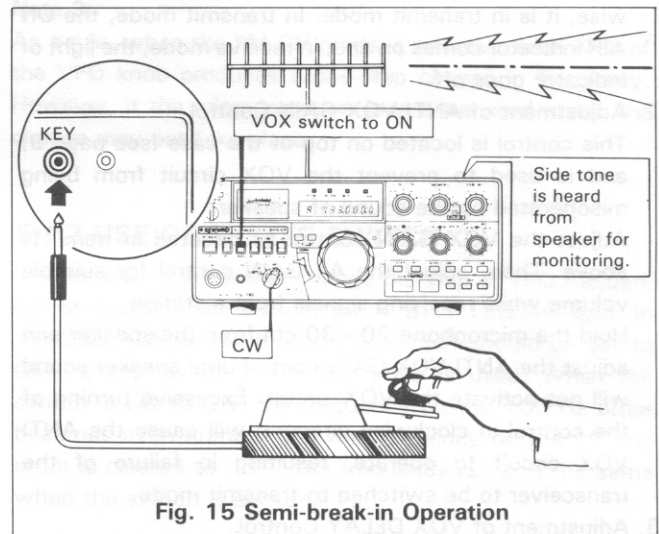

Fig. 15 Semi-break-in Operation

## 5-6 VOX OPERATION

The VOX is an automatic switching system that switches the transceiver to transmit and receive while speaking into the microphone. This is mainly used in SSB mode.

With the VOX switch set to ON, the transceiver is automatically switched to transmit mode when you speak into the microphone and to receive mode when you stop talking. For VOX operation, the standby switch should be set to REC.

### Control Settings

#### 1. Adjustment of VOX GAIN Control

With the standby switch set to REC, place the VOX switch in the VOX (ON) position.

First turn the VOX GAIN control clockwise and adjust it so that the transceiver is switched to transmit mode when you speak into the microphone with normal voice.

Turn the control further clockwise and the gain is increased allowing the transceiver to be switched to transmit mode with a lower level of voice. However, excessive VOX gain results in misoperation by ambient noise.

The condition of VOX operation can be checked through the speaker. When any sound is heard from the speaker, it means that the transceiver is in receive mode; otherwise, it is in transmit mode. In transmit mode, the ON AIR indicator comes on and, in receive mode, the light of indicator goes off.

#### 2. Adjustment of ANTI VOX GAIN Control

This control is located on top of the case (see page 9) and is used to prevent the VOX circuit from being misoperated by the sound of speaker.

Adjust the VOX GAIN control as directed in item (1) above. Then, adjust the AF GAIN control for suitable volume while receiving signals from a station.

Hold the microphone 20 ~ 30 cm from the speaker and adjust the ANTI VOX GAIN control until speaker sound will not activate the VOX circuit. Excessive turning of the control in clockwise direction will cause the ANTI VOX circuit to operate, resulting in failure of the transceiver to be switched to transmit mode.

#### 3. Adjustment of VOX DELAY Control

This control is used to hold the transmitter on after VOX operation. If the hold time is too short, the TS-780 returns to receive whenever you pause speaking. If too long, the TS-780 will not return to receive after speaking. Adjust the control so that the transceiver holds proper transmitting time when you speak at normal speed. This control is also effective for CW semi-break-in operation.

During CW operation, do not turn the control excessively in clockwise direction, as it takes a long time until the transceiver returns to receive when the key is released; making it impossible to perform smooth semi-break-in operation.

### Note:

If the VOX switch is left ON, the TS-780 will momentarily transmit when the POWER switch is turned on. After VOX operation, set the VOX switch to OFF.

## 5-7 READING THE FREQUENCIES

The TS-780 digital display indicates carrier positions in all operating modes. Because of the use of a special circuit, the carrier position remains the same when the MODE switch is manipulated, thus the transmit and receive frequency can be directly read on the digital display, except for CW reception where the frequency on the display is higher by the beat frequency (800 Hz: see section on "CW Mode") than the transmit frequency.

### Note:

The digital display does not indicate the frequency varied by the RIT knob.

## 5-8 BAND SWITCH (UP-DOWN)

The BAND switch consists of two pushbutton switches, UP and DOWN. By pressing the UP switch, the frequency is shifted up by 1 band and, by pressing the DOWN switch the frequency is shifted down by 1 band. By holding either switch down, the frequency is shifted continuously at 0.5 seconds intervals. As shown in the illustration below, the BAND switch functions separately for the VFO A and B (see section 5 ~ 9 on "Operation of 2 VFO's"). The BAND switch uses feather-touch pushbutton switches. A tone pulse is heard whenever the switch is pressed.

## 5-9 DIGITAL VFO

The TS-780 VFO is designed so that the pulses generated by rotating the VFO knob are counted by the microprocessor to vary the frequency through PLL circuit. The frequency is varied step by step. The step interval is 20 Hz (SLOW) for CW and SSB operation or 200 Hz (FAST) for fast-forward and FM operation. Either step can be selected by the S/F switch (see section 5-12).

The adjustable range of the digital VFO is shown in Table 1.

	F.STEP switch "OFF"	F.STEP switch "ON"
144 MHz BAND	144,000.00 ~ 145,999.98	144,000.00 ~ 145,999.80
430 MHz BAND	430,000.00 ~ 439,999.98	430,000.00 ~ 439,999.80

Table 1

Turning the VFO dial in either direction will shift the frequency in endless mode between 144.000.00 and 145.999.98 in the 144 MHz band. The dial also functions similarly in the 430 MHz band. Note that the upper limit of the band varies according to the position (ON/OFF) of the F. STEP switch or mode.



The VFO Knob is of variable torque type. When the lever at the left of the knob is set to NORM, the knob can be rotated quickly because of the flywheel effect. When the lever is set to TIGHT, the knob is given a heavy torque and hence the knob will not rotate accidentally by external shock. This feature is useful for fine tuning or mobile operation.

### 5-10 OPERATION OF 2 VFOs

The TS-780 has two VFO's, A and B, each being controlled by a microprocessor.

By using the FUNCTION switch, the desired VFO can be selected. The use of two VFO's also permits operation with their own frequencies (cross channel operation) such as A-R or B-R operation. The table below shows the positions of the FUNCTION switch and VFO's selected.

The two VFO's (A and B) can be operated in different bands (for example, VFO A: 144 MHz, VFO B: 430 MHz) or in the same band. They can also be used as a memory.

**Examples:**

1. With your contact's schedule frequency stored in VFO B, you can operate VFO A until your contact starts transmitting.
2. During FM operation, you can locate a sub-channel and shift the frequency for repeater operation by the VFO not in use.

FUNCTION SWITCH	RECEPTION	TRANSMISSION
A	A	A
B	B	B
A-R	A	B
B-R	B	A

Table 2

### 5-11 USE OF FM-CH

With the MODE switch set to FM-CH position, the VFO operation changes to click type. In the OFF position of the F. STEP switch, the channel frequency shifts up in 12.5 kHz steps, and in the ON position, in 5 kHz steps.

433.000	433.005
433.0125	433.010
433.0250	433.015
433.0375	433.020
⋮	⋮
433.9875	433.995

When the MODE switch is changed to or from FM-CH position, the operating frequency becomes as shown table 3.

MODE switch	SSB, CW, FM—FM-CH		FM-CH—SSB, CW, FM	
F. STEP switch	OFF → ON		OFF → ON	
Frequency displayed	145.317.7	145.317.6	145.315.0	145.315
	145.312.5 (NOTE: * 1)	145.315 (NOTE: * 2)	145.315.0	

Table 3

**Note 1:**

\* 1 When the F. STEP switch is turned OFF, the frequency will shift to the nearest 12.5 kHz step frequency within the displayed frequency.

\* 2 When the F. STEP switch is turned ON, the frequency will shift the nearest 5 kHz step frequency within the displayed frequency.

The 100 Hz digit disappears.

**Note 2:**

Table 3 shows the frequencies of VFO A. In the FM-CH mode, the frequency of VFO B is shifted in the same way. In the SSB mode, the frequency below 10 kHz order may be changed.

**Note 3:**

As a rule, when the FM-CH mode is selected, each click of the VFO knob produces a one-step change in frequency. However, if the microcomputer is in a transient state, the change may not take place.

### 5-12 USE OF F. STEP SWITCH

This switch is used to change the step of VFO frequency. By pressing the switch, the F. STEP LED will light. In the SSB, CW or FM mode, this switch should be set to OFF, except when the tuning knob is used. When the switch is set to ON, the frequency on the 100 Hz order becomes even number and the frequency on the 10 kHz order is cleared to "0". The frequency remains the same when the switch is set to OFF.

F. STEP switch \ MODE	SSB, CW, FM	FM-CH
OFF	20 Hz	12.5 kHz
ON	200 Hz	5 kHz

Table 4

### 5-13 USE OF MEMORY

This switch is used to store the desired frequency in the memory. The frequency is stored in the channels (1-10 ch) by using the M switch and MEMORY selector. The stored frequency is called out by pressing the MR switch to ON.

- 1 Select the desired frequency by the tuning knob.
- 2 Select the desired channel by the MEMORY selector to store the frequency.
- 3 Depress the MR switch to ensure that the selected channel is not occupied. Occupied channels can be cleared as necessary.
- 4 Depress the M switch and an oscillation sound is heard, indicating that the frequency is stored in the memory.

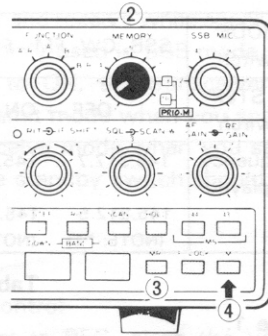
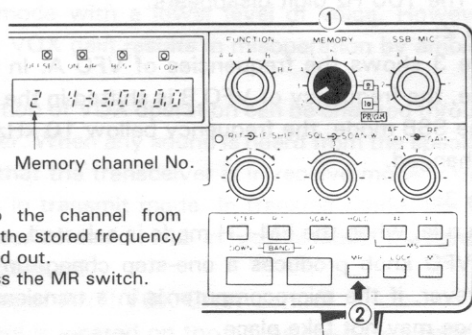

Fig. 14 Use of MEMORY



- 1 Set to the channel from which the stored frequency is called out.
- 2 Depress the MR switch.

Fig. 15 MEMORY Recall

The channels (9, 10) are for PRIO. M channels. In the 9 ch, 145.000.0 MHz is stored and, in the 10 ch, 433.000.0 MHz is stored. These frequencies can be changed as desired. In this case, the PRIO. M channels (9, 10) are also changed.

**Note 1:** The PRIO. M channels (9, 10) are the same as the channels (9, 10) called out by the MR switch.

**Note 2:** When an empty channel is called out, only the channel No. is indicated on the display.

**Note 3:** When the channels (9, 10) are called out by the MR switch, the channel No. is indicated as "C, c".

**Note 4:** When a frequency, stored in ON position of F. STEP switch, is called out, the F. STEP LED will light.

**Note 5:** Frequency down to 10 Hz order is stored, but the frequency change due to RIT is not stored.

**Note 6:** In the FM-CH mode, the frequencies on the 1 kHz-10 Hz order are stored as "0". When called out, the full frequency is indicated on the display.

**Note 7:** In repeater operation, when a frequency is stored during transmission, only the frequency which is not shifted is stored.

## 5-14 USE OF SCAN SWITCH

With the SCAN switch ON, the FUNCTION (A, b) flickers to indicate that the frequency is scanned.

### FM-CH mode

1. Adjust the squelch sensitivity by the SQL VR and set the signal level for BUSY stop.
2. By setting the SCAN switch to ON, the channel is shifted to the next one regardless whether a signal is present in the channel (If the switch is kept depressed, the channel is not shifted).
3. Even when the channel is BUSY stopped, the function keeps flickering.
4. When signal is absent in the BUSY stop channel, the SCAN stops for about 1 seconds and starts again.

### FM mode

1. Depress the SCAN switch continuously and the channel is scanned at a high speed. In BUSY stop, keep the switch depressed to fast forward the signal beyond the receiving band. In this way, the scan is restarted smoothly.
2. Other operations are the same as in the FM-CH mode.

### Other modes

1. Search operation only; BUSY stop is not used. Depress the HOLD switch or transmit signals. The scan is released and the FUNCTION stops flickering.

### Use of SCAN W Switch

The SCAN W switch is used to adjust the scan width. The scan width is changed according to the frequency at the start of scan. The following shows the operation of the SCAN W switch in the FM-CH mode where the frequency is scanned starting from 431.637.5 MHz.

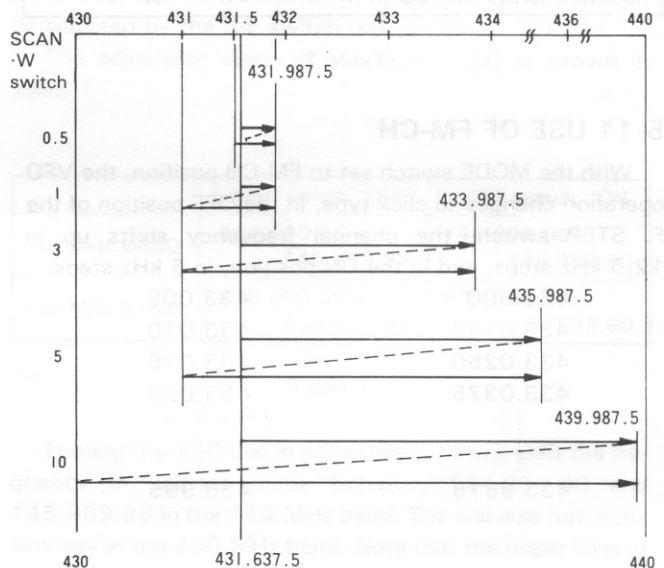

Fig. 16

[0.5 MHz]

When the scan, starting from 431.637.5 MHz, reaches the upper limit 431.987.5 MHz, it jumps down to the lower limit 431.500.0 MHz where the scan is started again. This action is repeated while holding 0.5 MHz width.

[1 MHz]

When the scan reaches from 431.637.5 MHz to the upper limit 431.987.5 MHz, it jumps down to the lower limit 431.000.0 MHz and reaches 431.987.5 MHz again. This action is repeated while holding 1 MHz width.

[3 MHz]

Similarly, when the scan reaches from the lower limit 431.000.0 MHz to the upper limit 431.637.5 MHz, it jumps down to the lower limit and reaches the upper limit again. This action is repeated while holding 3 MHz width.

The lower limit is 431.637.5 MHz minus the frequency on 100 kHz order, and the upper limit is 433.987.5 MHz, one step lower than 434.000.0 MHz which is the lower limit plus 3 MHz but the scan starts from 431.637.5 MHz. [5 MHz]

The upper and lower limits are calculated in the same manner as for 3 MHz width. The scan is repeated between the lower limit and the upper limit while holding 5 MHz width.

[10 MHz]

The scan is repeated between the upper limit 439.987.5 MHz and the lower limit 430.000.0 MHz while holding 10 MHz width.

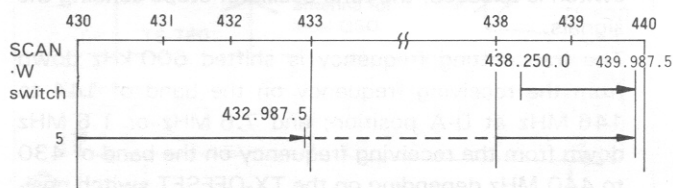

**Note 1:** In the SCAN W position 3, 5 or 10, the scan in the 144 MHz band is repeated between the upper limit 145.987.5 MHz and the lower limit 144.000.0 MHz.

**Note 2:** In these position, the scan does not shift over the 144 and 430 MHz bands. For example, when the SCAN W is 5 in 438.250.0 MHz, the scan is effected holding 5 MHz width.

**Note 3:** The scan width should be calculated even in the following cases:

- 1) When VFO (A, B) is switched.
- 2) When SCAN W switch is set to another position.
- 3) When BAND switch is depressed.

**Note 4:** The scan width remains unchanged when the SCAN switch is depressed for BUSY stop. To change the scan width, the scan should be released.

**Note 5:** The BAND switch can be used during scan operation, but it does not function continuously when it is kept depressed. This switch also functions even when the F. LOCK switch is ON.

The scan is released when the PRIO. M, MR or MS switch is set to ON.

## 5-15 USE OF MS (MEMORY SCAN) SWITCH

When the 144 MS or 430 MS switch is set to ON, the function (CH No.) flickers to indicate that the memory channels (1-10 ch) can be scanned (the squelch threshold should be set as in the case of VFO scan).

With the 144 MS switch ON, the memory channel for 144 MHz band can be scanned. With the 430 MS switch ON, the memory channel for the 430 MHz band is scanned. When both switches are ON, all the channels (both for 144 and 430 MHz bands) are scanned. To hold the scan, use the procedure for VFO scan. To restart the scan, set the SCAN switch to ON.

**Note 1:** Scan is not effected when the SCAN switch is kept depressed.

**Note 2:** When scan is held in the ON position of both MS switches, it can be restarted by setting either switch to OFF or by pressing the CALL or MR switch.

**Note 3:** When all the channels are 144 MHz band and the 430 MS switch is set to ON, the function flickers quickly and a oscillation sound is heard continuously. This also occurs when all the channels are 430 MHz band and the 144 MS switch is set to ON.

**Note 4:** Only memorized channels are scanned.

## 5-16 USE OF PRIO. M CHANNEL

With the PRIO. M 9 or 10 switch set to ON, stored frequencies in the memory channels 9 or 10 can be recalled with first priority. In the channel 9 and 10. 145.000.0 MHz and 433.000.0 MHz are preset respectively, while any frequency can be memorized in each channel. Display of the PRIO. M channel is as follows:

$\bar{c}$  145.000.0 or  $\bar{c}$  433.000.0

**Note: 1** The PRIO. M 9 is prior to the PRIO. M 10.

**Note: 2** The PRIO. M channel frequency is displayed to 100 Hz digit.

## 5-17 BACKUP OF MEMORY CHANNEL FREQUENCY

Any desired memory channel frequency can be stored in the RAM (Random Access Memory) of the micro-computer. But the data (frequency) in the RAM is cleared when the power switch is set to OFF. The transceiver has its own built-in backup circuit to hold the data (frequency) even when the power switch is OFF during both AC and DC operations. By loading backup battery in the transceiver battery case, the battery power is always supplied to the backup circuit. In this way, the data is not cleared regardless of the position of the power switch. The backup

current is less than 10  $\mu$ A and the battery lasts for about one year. When the backup circuit is not used, the VFO frequency returns to 144.000.0 MHz in the OFF position of the power switch.

### 5-18 OPERATION ON EXTERNAL DC POWER (MOBILE OPERATION)

The TS-780 also operates on external DC power (DC13.8 V  $\pm$  15%) for mobile operation.

#### Installation

The method of mobile operation is basically the same as that of fixed station operation.

Select a suitable location for installation of the transceiver. The installation location may vary depending on the size and structure of car. The transceiver may be placed on the passenger's seat; in this case, it should be secured with the seat belt so that it will not drop off the seat if the car stops suddenly.

#### Mobile Antenna

Various types of mobile antennas are available for use on 144 and 430 MHz bands. You can use a 1/4 wavelength whip antenna, ground plane antenna or 5/8 wavelength antenna.

#### Note:

Most roof mount antennas are designed so that the antenna base is earthed to the car body. Mount the antenna securely referring to the instruction manual supplied with the antenna.

#### DC Cable

When the transceiver is to be operated from DC power, a DC power cable with an 7 A fuse should be used.

In DC operation, please prepare a DC cable as Fig. 18.

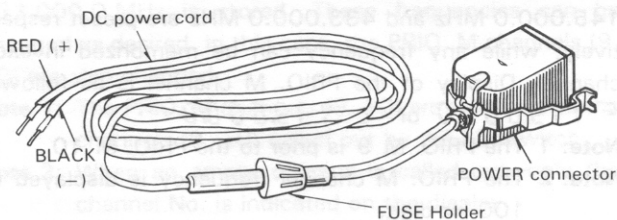

Fig. 18 DC Cable

#### Battery Capacity

During mobile operation, the transceiver draws about 5 A of current, so a battery having about 35AH of capacity is sufficient for proper transceiver operation. However, since the battery is given an additional load, it is advisable to use the transceiver while the car engine is operating.

#### Note:

To insure safe driving of car, it is recommended that the transceiver be operated in fixed channel mode.

### 5-19 REPEATER OPERATION

The TS-780 is capable of the following repeater operations on the bands of 144 MHz to 146 MHz and 430 MHz to 440 MHz.

		Frequency Shift
144 to 146 MHz	D-A	- 600 kHz
	D-B	+ 600 kHz
430 to 440 MHz	D-A	- 7.6 MHz
	D-B	- 1.6 MHz

In the D-A position, the transmitting frequency is 7.6 MHz lower than the receiving frequency. In the D-B position, the transmitting frequency is 1.6 MHz lower than the receiving frequency.

If the transmitting frequency is outside of the amateur band, the digital display goes out and no signals will be transmitted.

#### Operating Procedure:

- 1) Turn the band switch to the position representing the operating frequency.
- 2) Set the TX-OFFSET switch to the appropriate position. The OFFSET indicator lights.
- 3) Turn the VFO dial to the desired receiving frequency, and push the TONE switch. The built-in tone oscillator circuit (1,750 Hz) operates to send the 1,750 Hz-modulated signal to operate a repeater station. The TONE switch is a non-lock type so that, when the switch is released, the tone oscillator stops sending the signals.

The transmitting frequency is shifted 600 kHz down from the receiving frequency on the band of 144 to 146 MHz at D-A position; and 7.6 MHz or 1.6 MHz down from the receiving frequency on the band of 430 to 440 MHz depending on the TX-OFFSET switch position. The shifted frequencies are digitally indicated.

If any of the shifted frequencies is outside of the amateur band, the digital display goes out, and no signals will be transmitted.

The REV switch is used to check repeater input signal. By depressing that switch, the TX and RX frequencies are reversed.

In case of other shift repeaters, set the SHIFT switch to SIMP, and the function switch to A-R or B-R.

For example, in case of a repeater station with a shift of + 1.6 MHz from 433 MHz, set the function switch to the A-R position, VFO-A to 433.0 MHz and VFO-B to 434.6 MHz.

Then the TS-780 receives 433.0 MHz and transmits 434.6 MHz signals.

In a similar way, repeater operations of other shifts are possible.

### 5-20 OSCAR OPERATION

At present, two amateur radio communication satellites (No. 7 and No. 8) are travelling along the orbit of the earth (No. 6 is not available because the battery power has been exhausted). These satellites can be used as your repeater. The TS-780 will function when used with the satellites as follows.

**[OSCAR No. 7]**

- A mode: 2 m ~ 10 m ..... Repeater up-link transmitter
- B mode: 70 cm ~ 2 m ..... Repeater up-link transmitter  
or Repeater down-link receiver

**[OSCAR No. 8]**

- A mode: 2 m ~ 10 m ..... Repeater up-link transmitter
- J mode: 2 m ~ 70 cm ..... Repeater up-link transmitter  
or Repeater down-link receiver

**[RADIO 1,2]**

- 2 m ~ 10 m ..... Repeater up-link transmitter

Table 5 shows the link frequencies. An example of application of the TS-780 in 70 cm ~ 2 m repeater operation is illustrated in Fig. 19.

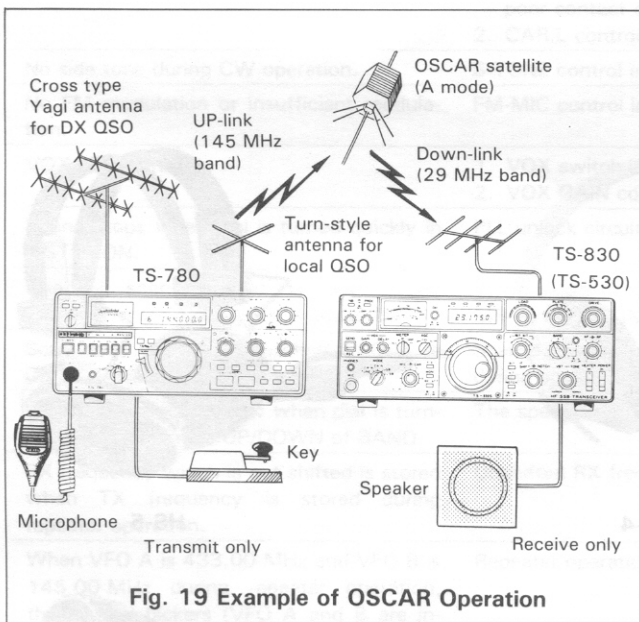

	OSCAR No. 7		OSCAR No. 8		RADIO No. 1, 2 (2m-10m)
	A mode (2m-10m)	B mode* (70cm-2m)	A mode (2m-10m)	J mode* (2m-70cm)	
Up-link frequency	145.85 to 145.95	432.125 to 432.175	145.85 to 145.95	145.9 to 146.0	145.88 to 145.92
Down-link frequency	29.40 to 29.50	145.975 to 145.925	29.40 to 29.50	435.1 to 435.2	29.360 to 29.400
Beacon frequency	29.502	145.972	29.402	435.097	29.400

\* B or J mode are received by LSB mode.

**Table 5**

OSCAR operation with the TS-780 alone where the FUNCTION switch is set to A-R and the VFO A is used as a 430 MHz band receiver and the VFO B as a 145 MHz band transmitter, is not possible because the down-link signal cannot be monitored.

In OSCAR operation, it is imperative to use a separate transmitter and receiver so that the down-link signal can be received as shown in Fig. 19. It is also necessary for you to become acquainted with some special knowledges relative to the orbit tracking of satellite, usage of beacon waves, operating manner, antenna installation, etc.

With basic knowledges, you will be able to enjoy repeater communication through the amateur satellites with little difficulty. Reference materials such as guide books and instruction books are available from market.

### 5-21 AUX SOCKET

This socket is used for connecting the supplied DIN connector to supply the following voltages to external equipment.

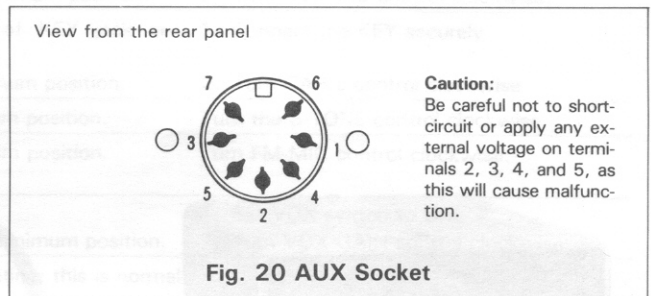

Terminal No.	Symbol	Application
1	NC	Open terminal
2	E43	8 V DC 10 mA (430 MHz)
3	ELC	External ALC input terminal
4	14C	8 V DC 10 mA (144 MHz)
5	9T	9 V DC 10 mA at transmit
6	NC	Open terminal
7	SS	External standby terminal. Transmitter operates when earthed.

**Table 6**

The AUX socket is used for connection to a linear amplifier, receiver booster or external standby unit. When using care should be taken so that each of the load currents at the terminals 2, 4 and 5 will not exceed 10 mA, as otherwise the transceiver may be damaged.

## SECTION 6. OPTIONAL ACCESSORIES

The following optional accessories are available with the TS-780.

- **Communication External Speaker SP-71**

This speaker provides clear, natural tone with the use of a high-cut cone, best suited for communication use.

- **Communication Headphones HS-4**

Specifically designed with consideration given to the shape of ear pads, materials and weight to insure many hours of fatigues listening. The impedance is 8 ohms.

- **High Class Communication Headphones HS-5**

The most ideal headphones with "open air" type ear pads to eliminate pressure to the head and ears and to provide natural tone. The open air type ear pads can be readily replaced with the pressure type ones.

- **Light-weight Communication Headphones HS-6**

Specifically designed to reduce the weight and to improve the tone quality.

- **Ham Clock HC-10**

The HC-10 is a highly advanced world clock with dual display which memorizes 10 world major cities and 2 additional regions.

- **De-Luxe Fixed Station Microphone MC-60/S8**

Communication microphone with a piano-touch PTT switch specifically designed for fixed station operation.



SP-71



HS-4



HS-5



HS-6



HC-10



MC-60/S8

## SECTION 7. TROUBLE SHOOTING

SYMPTOMS	CAUSE	COUNTERMEASURE
No receiver noise from speaker in FM mode.	Squelch circuit is ON.	Turn SQUELCH control counterclockwise.
Transceiver is connected to antenna, but no signal is received, while "S" meter pointer remains deflected.	<ol style="list-style-type: none"> <li>1. Antenna connectors for 144 and 430 MHz bands are not connected correctly.</li> <li>2. Squelch is ON.</li> <li>3. Microphone PTT switch is depressed.</li> </ol>	<ol style="list-style-type: none"> <li>1. Check antenna and connect correctly.</li> <li>2. Turn squelch control counterclockwise.</li> <li>3. Set PTT switch to receive position.</li> </ol>
Even in the absence of signal, "S" meter pointer remains deflected.	RF GAIN control is set too low.	Turn RF GAIN control fully clockwise.
SSB signal is being received but speaker.	Transceiver is set for opposite side band.	Set MODE switch to LSB or USB.
RIT control inoperative.	RIT switch is OFF.	Set RIT switch to ON (indication of digital display remains the same).
SSB receive signal is in "high cut" or "low cut".	Maladjustment of IF SHIFT.	Set the control in the center (detent) position.
No transmit output (SSB).	<ol style="list-style-type: none"> <li>1. Poor contact of MIC jack or plug.</li> <li>2. SSB MIC control in minimum position.</li> </ol>	<ol style="list-style-type: none"> <li>1. Connect the microphone plug securely.</li> <li>2. Turn SSB MIC control clockwise.</li> </ol>
No transmit output (CW).	<ol style="list-style-type: none"> <li>1. Improper connection of KEY jack or poor contact of KEY.</li> <li>2. CAR.L control in minimum position.</li> </ol>	<ol style="list-style-type: none"> <li>1. Connect the KEY securely.</li> <li>2. Turn CAR.L control clockwise.</li> </ol>
No side tone during CW operation.	S-TONE control in minimum position.	Turn the S-TONE control clockwise.
No FM modulation or insufficient modulation.	FM-MIC control in minimum position.	Turn FM-MIC control clockwise.
VOX not operating.	<ol style="list-style-type: none"> <li>1. VOX switch is OFF.</li> <li>2. VOX GAIN control in minimum position.</li> </ol>	<ol style="list-style-type: none"> <li>1. Set VOX switch to ON.</li> <li>2. Turn VOX GAIN control clockwise.</li> </ol>
Sound stops when dial is turned quickly in F.STEP ON.	PLL unlock circuit is operating; this is normal and is not an indication of trouble.	
Channel scanned first is not clearly indicated when MS switch is set to ON.	When signal is present in the first channel, the scan busy stops (FM, FM-CH mode). Set MS switch to ON once again, or wait until the scan completes one cycle.	
Scan does not continue when F.LOCK is ON or BAND SW is depressed.	Scan operation is effected even when F.LOCK is ON. The BAND UP/DOWN is possible during scan operation.	
UP/DOWN speed is slow when dial is turned during continued UP/DOWN of BAND.	The speed is controlled by the dial.	
RX frequency which is not shifted is stored when TX frequency is stored during repeater operation.	Unshifted RX frequency is stored during repeater operation.	
When VFO A is 433.00 MHz and VFO B is 145.00 MHz during repeater operation, the display flickers (VFO A and B are indicated alternately) at function A-R TX OFF SET "-" or "+" and REV SW ON.	Repeater operation at A-R and B-R is complex. Use the A or B position.	
When the power switch is set to OFF and ON without using the backup circuit, VFO and memory CH are not reset properly.	Set the power switch to ON more than 10 seconds after it has been set to OFF.	
When there is a faulty indication.	Set the power switch to OFF (when using the back-up function, this should be done after removing the batteries), and reset it to ON after a few seconds. Check that the switch has been correctly reset before inserting the batteries.	

# BLOCK DIAGRAM

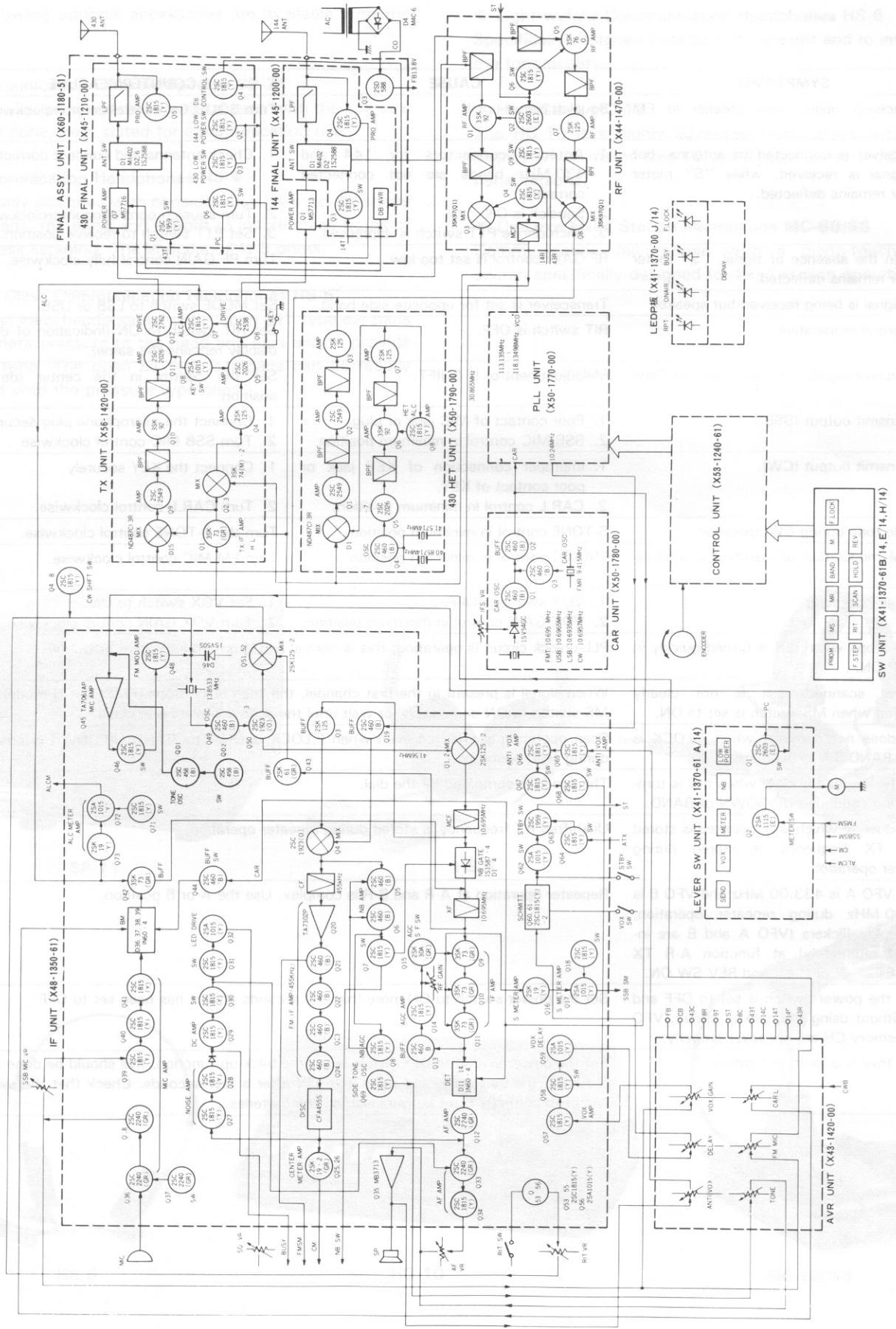



# SCHEMATIC DIAGRAM

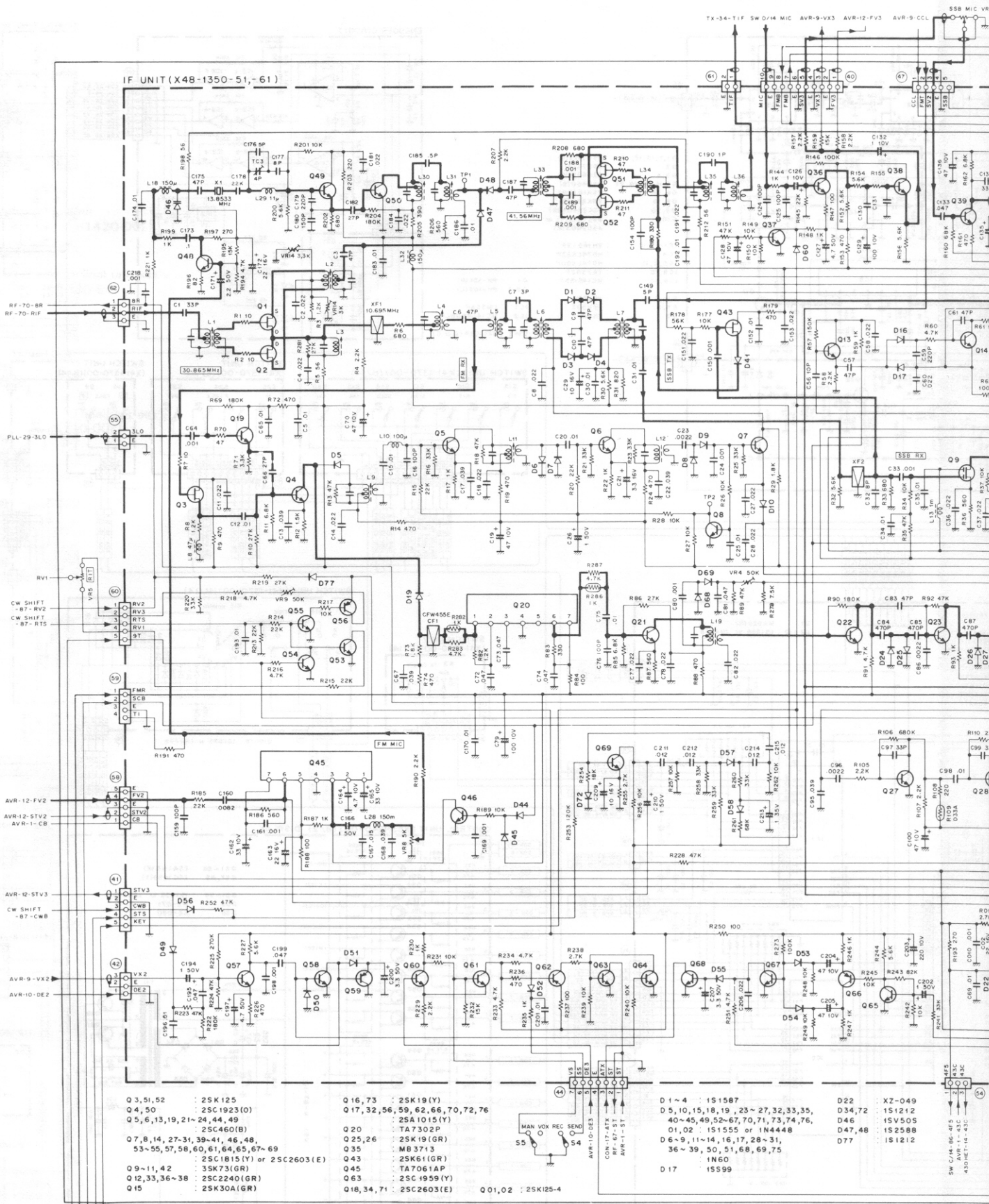

- |  |                            |                                      |              |  |                    |          |           |
|--|----------------------------|--------------------------------------|--------------|--|--------------------|----------|-----------|
| Q 3, 51, 52  | : 25K125                   | Q 16, 73                             | : 25K19(Y)   | D 1 ~ 4  | : 1S1587           | D 22     | : XZ-049  |
| Q 4, 50  | : 25C1923(O)               | Q 17, 32, 56, 59, 62, 66, 70, 72, 76 | : 25A1015(Y) | D 5, 10, 15, 18, 19, 23 ~ 27, 32, 33, 35, 40 ~ 45, 49, 52 ~ 67, 70, 71, 73, 74, 76, 01, 02 | : 1S1555 or 1N4448 | D 34, 72 | : 1S1212  |
| Q 5, 6, 13, 19, 21 ~ 24, 44, 49  | : 25C460(B)                | Q 20                                 | : TA7302P    | D 6 ~ 9, 11 ~ 14, 16, 17, 28 ~ 31, 36 ~ 39, 50, 51, 68, 69, 75                             | : 1N60             | D 46     | : 15V50S  |
| Q 7, 8, 14, 27 ~ 31, 39 ~ 41, 46, 48, 53 ~ 55, 57, 58, 60, 61, 64, 65, 67 ~ 69 | : 25C1815(Y) or 25C2603(E) | Q 25, 26                             | : 25K19(GR)  | D 17   | : 15S99            | D 47, 48 | : 15S2588 |
| Q 9 ~ 11, 42   | : 25C1815(Y) or 25C2603(E) | Q 35                                 | : MB3713     |  |                    | D 77     | : 1S1212  |
| Q 12, 33, 36 ~ 38  | : 25C2240(GR)              | Q 43                                 | : 25K51(GR)  |  |                    |          |           |
| Q 15   | : 25K30A(GR)               | Q 45                                 | : TA7061AP   |  |                    |          |           |
|  |                            | Q 63                                 | : 25C1959(Y) |  |                    |          |           |
|  |                            | Q 18, 34, 71                         | : 25C2603(E) |  |                    |          |           |
|  |                            | Q 101, 02                            | : 25K125-4   |  |                    |          |           |

TX-34-T1F SW D/14 MIC AVR-9-VX3 AVR-12-FV3 AVR-9-CCL 55B MIC VR  
 55B TR  
 30.865MHZ  
 10.635MHZ  
 30.865MHZ  
 55B RX  
 MAN VOX REC SEND  
 AVR-10-DE2  
 SW 6/14-86-4F5 430/463-14-41C

# GRAM (IF Unit)

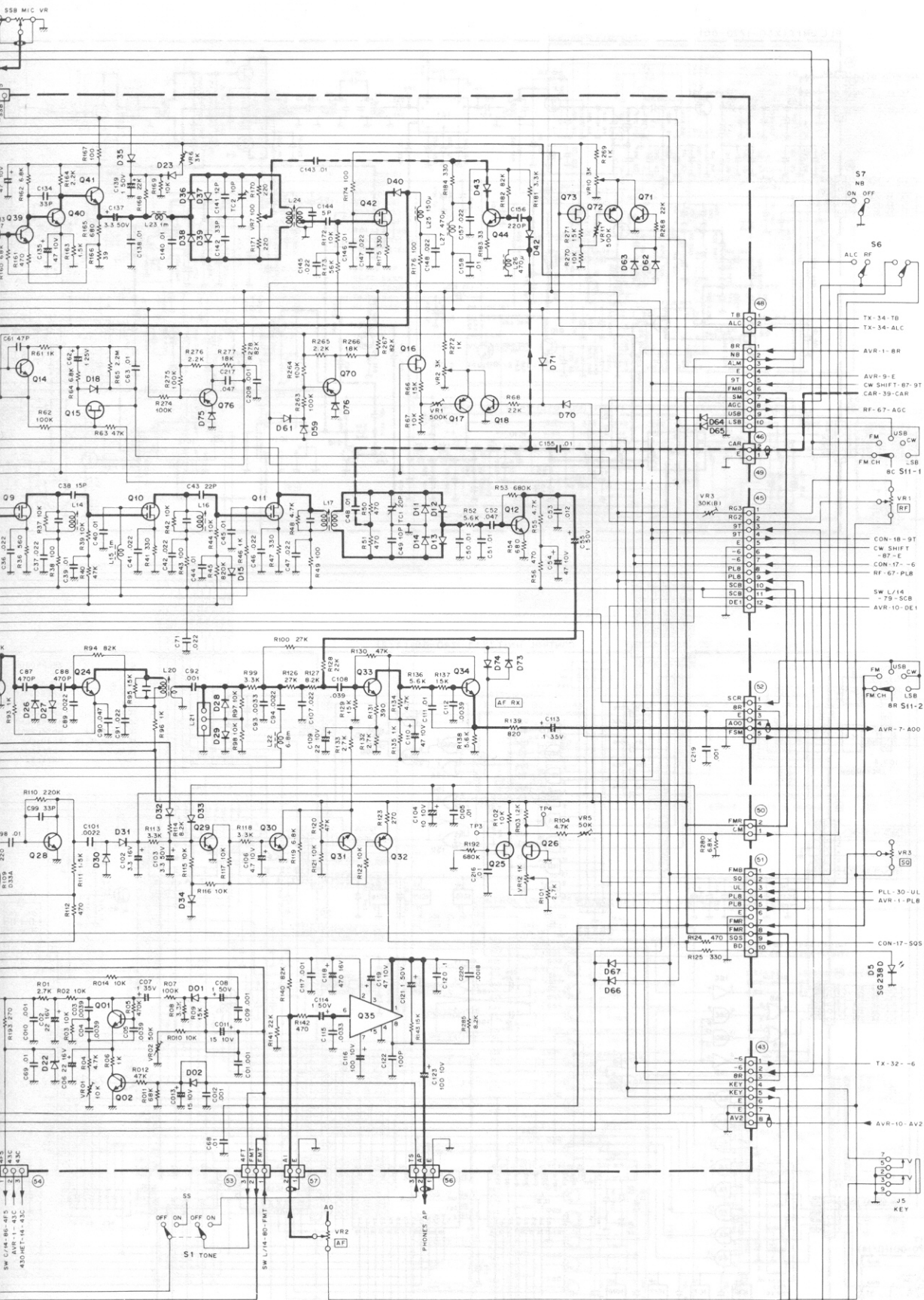

# SCHEMATIC DIAGRAM (PLL)

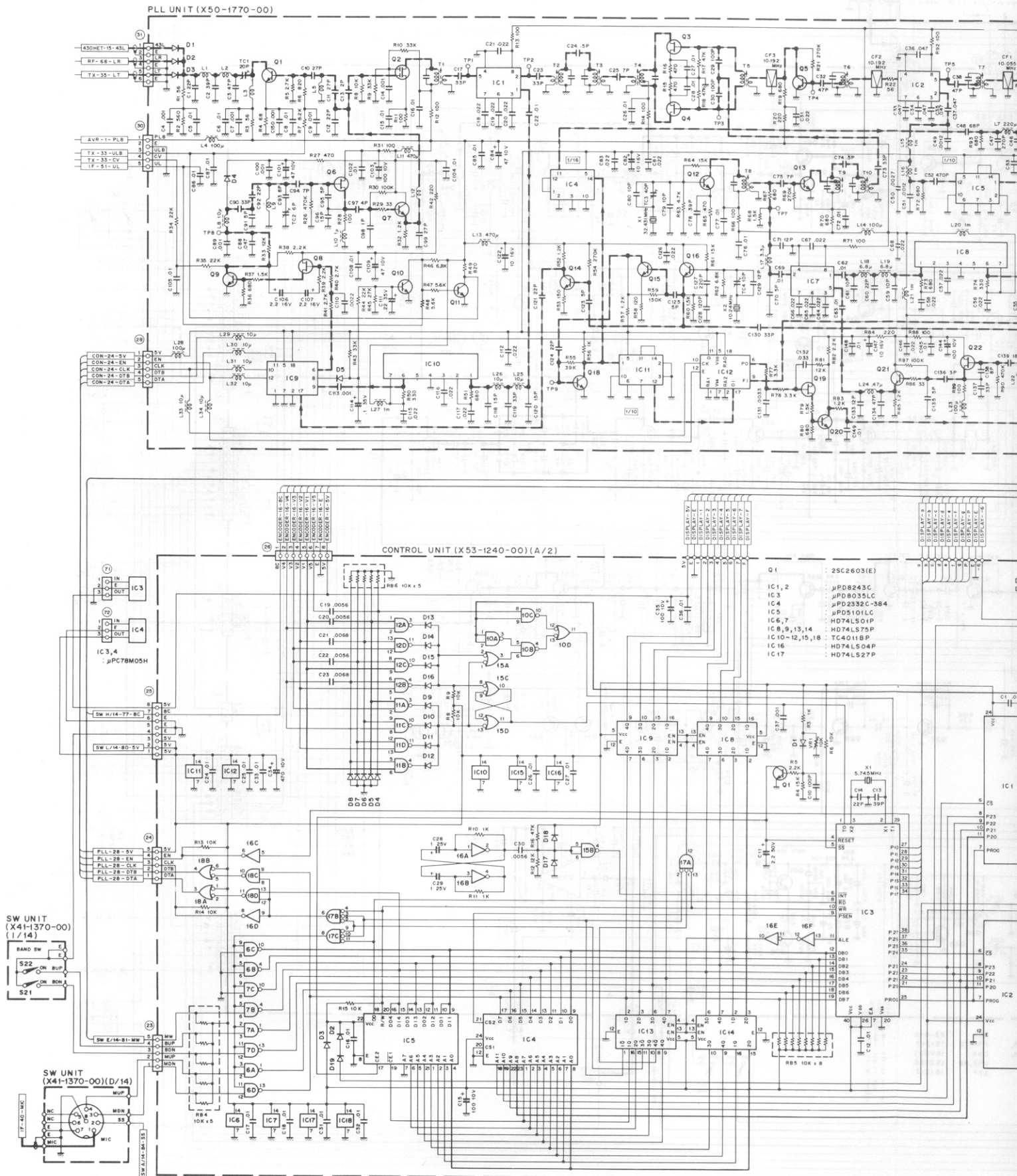

# MAIC (PLL & CONTROL Unit)

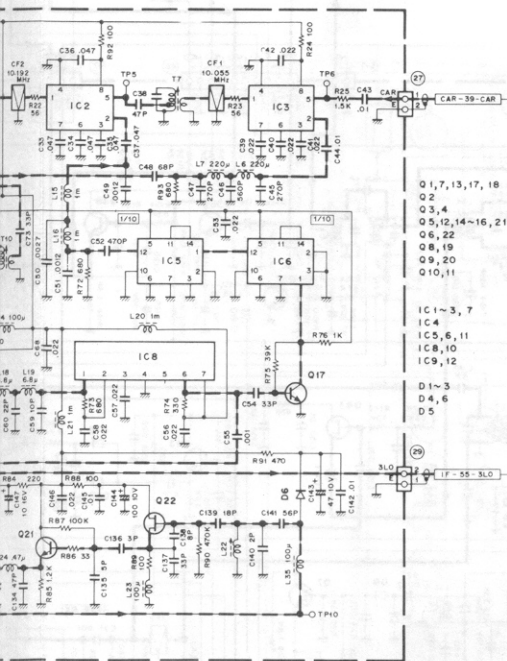

- Q1,7,13,17,18 : 2SC1923(O)
- Q2 : 3SK73(V)
- Q3,4 : 2SK61(GR)
- Q5,12,14~16,21 : 2SC460(B)
- Q6,22 : 2SK19(GR)
- Q8,19 : 2SK30A(O)
- Q9,20 : 2SC240(GR)
- Q10,11 : 2SC1815(Y) or 2SC2603(E)
- IC1-3,7 : SN16913P
- IC4 : HD74LS93P
- IC5,6,11 : HD74LS90P
- IC8,10 : TA7302P
- IC9,12 : MC145155P
- D1~3 : 1S2588
- D4,6 : 1SV505
- D5 : 1N60

- Q1 : PH-101(R)
- Q2,3 : PH-102(L)
- IC1 : LM358P
- IC2 : MC14049UBCP
- D1-3 : SEL101R(B or C)

## ENCODER CIRCUIT

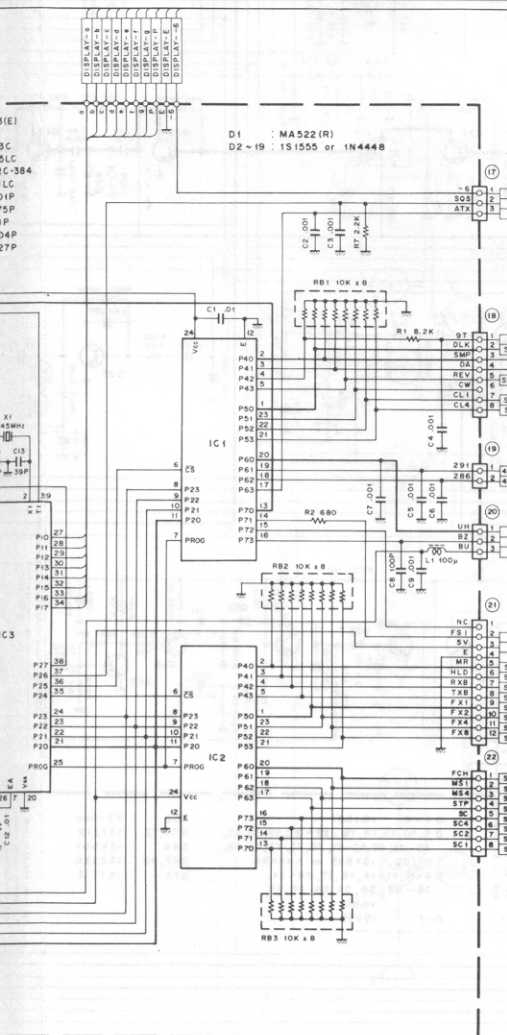
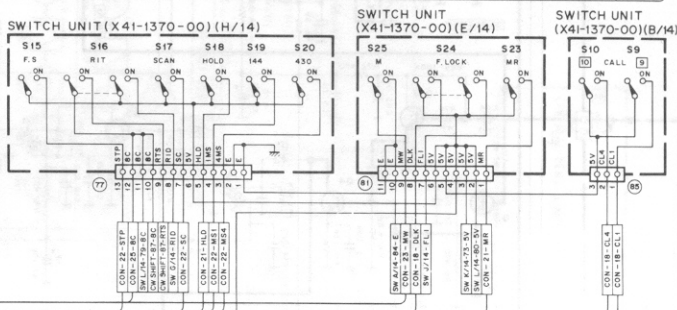
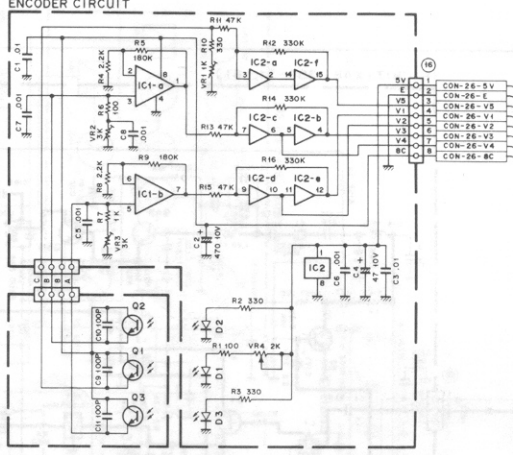

- D1 : MA522(R)
- D2-19 : 1S1555 or 1N4448

## SWITCH UNIT (X41-1370-00)(C/14)

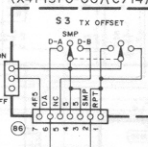

## SWITCH UNIT (X41-1370-00)(M/14)

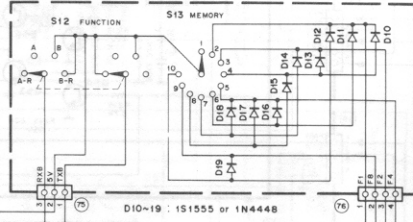

## CONTROL UNIT (X53-1240-00)(B/2) DISPLAY

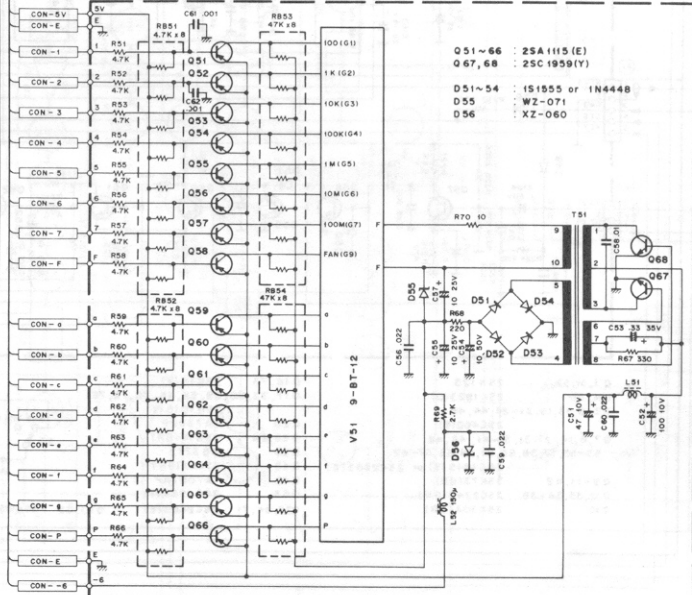

- Q51~66 : 2SA1115(E)
- Q67,68 : 2SC1959(Y)
- D51~54 : 1S1555 or 1N4448
- D55 : W2-071
- D56 : XZ-060

RF UNIT (X44-1470-00)

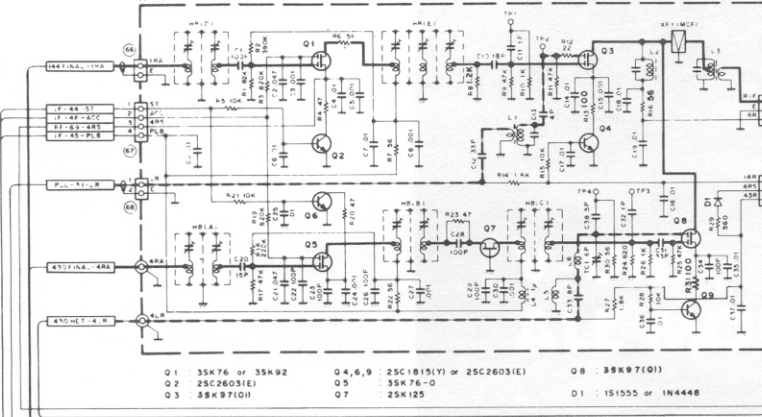

430 HET UNIT (X50-1790-00)

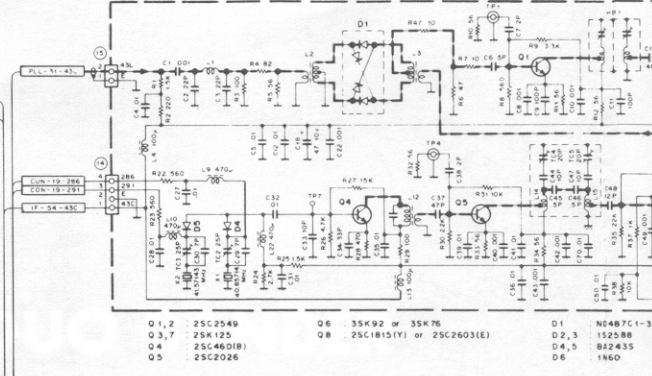

TX UNIT (X56-1420-00)

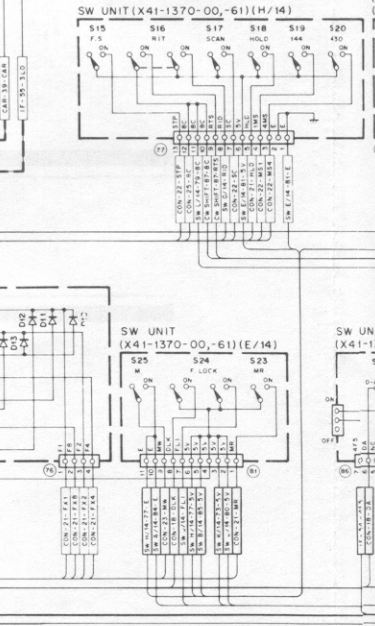
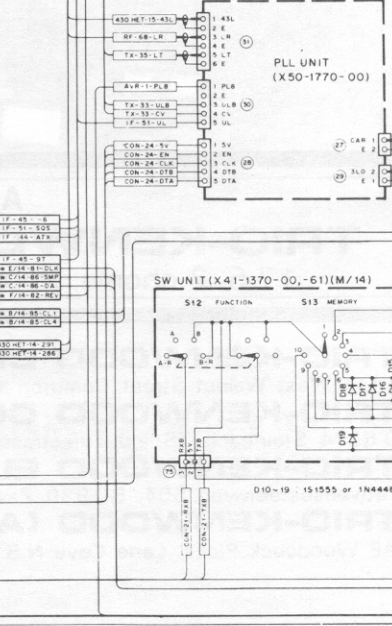
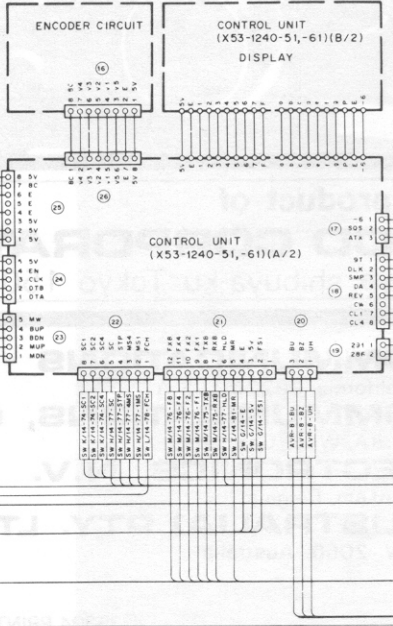
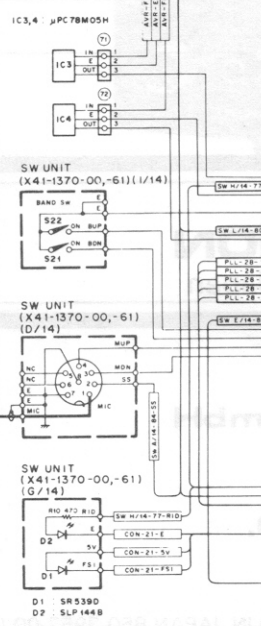
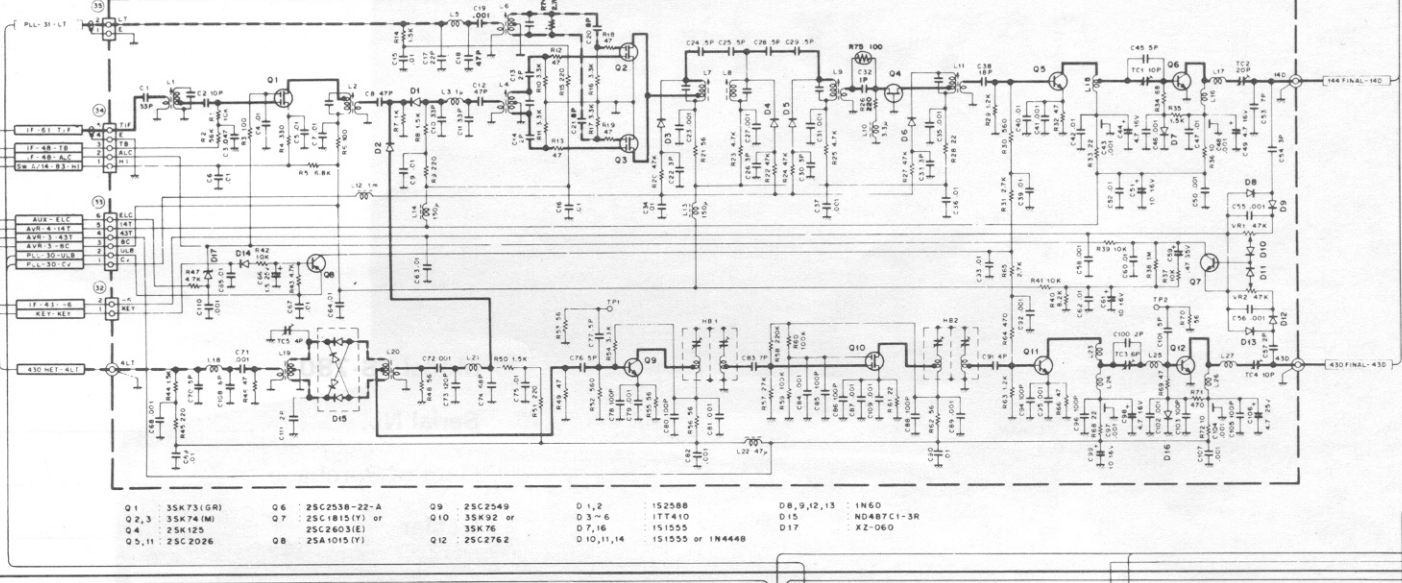

# TS-780 SCHEMATIC DIAGRAM

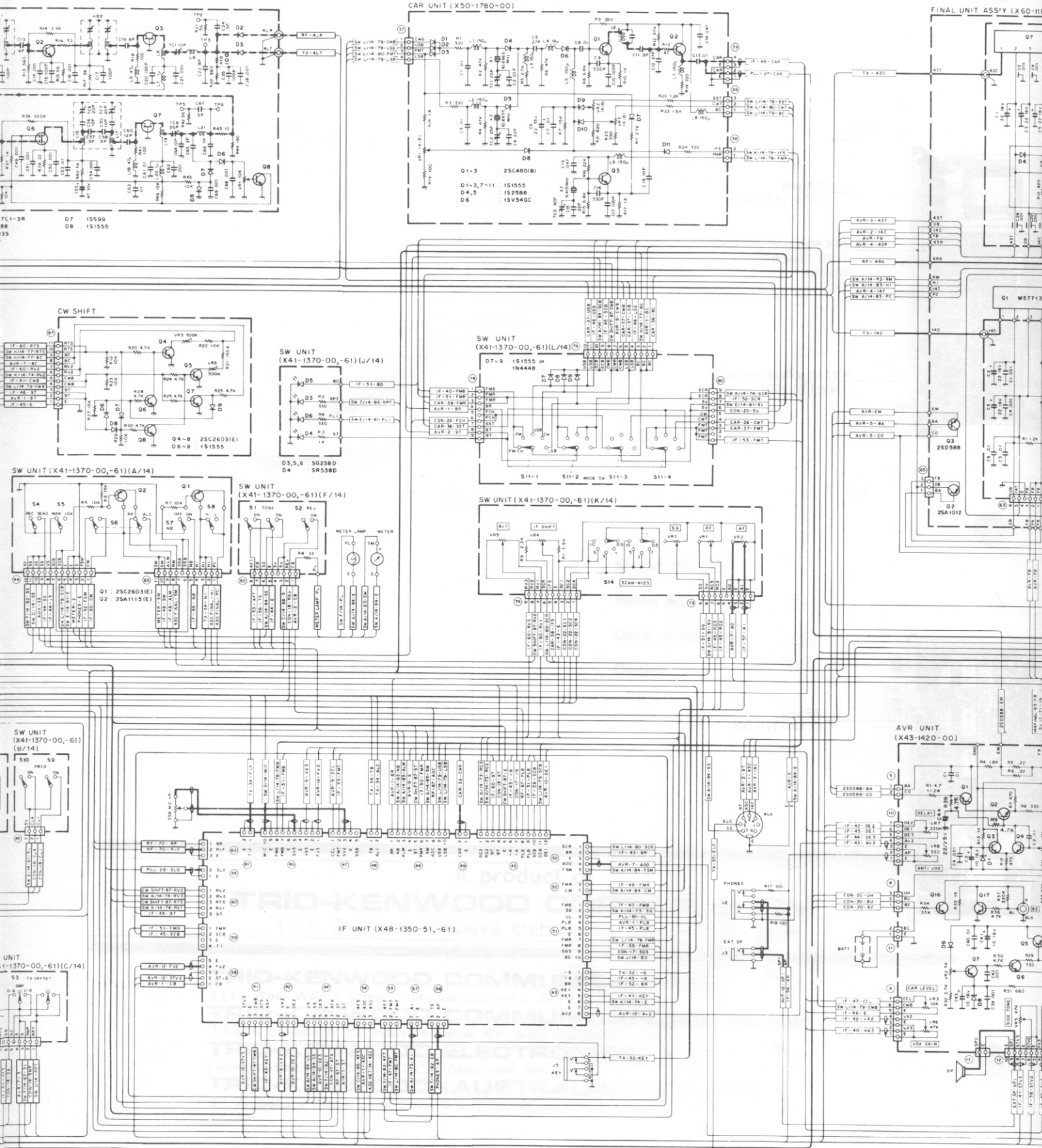

FINAL UNIT ASSY (X60-1180-51)

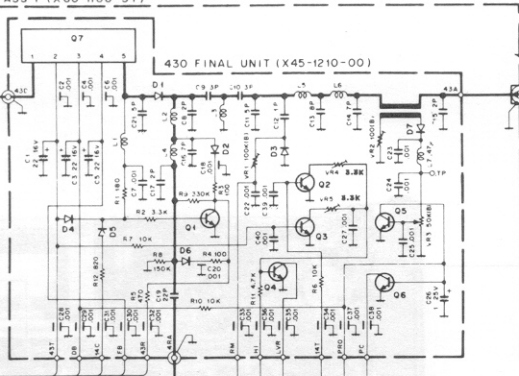

- Q1 25C1959(Y)
- Q2-6 25C1815(Y)
- Q7 M57716
- D1 M1402
- D2,6 152588
- D3 151587
- D4,5 151555 or 1N4448
- D7 15599

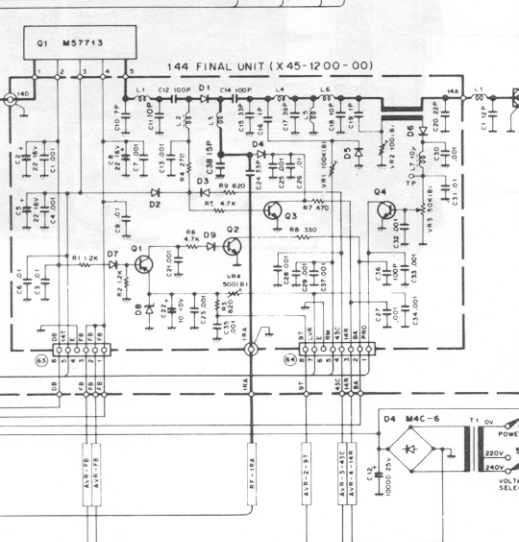

- Q1 25A1015(Y)
- Q2 25C1959(Y)
- Q3,4 151555 or 25C2603(E)
- D1 M1402
- D2,3,7,9 151555 or 1N4448
- D4 152588
- D5 151587
- D6 1N60
- D8 XZ-064

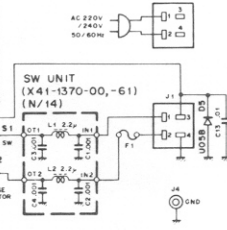

- IC1 JPC78M08H
- IC2 MB3756
- D1 XZ-080
- D2 XZ-078
- D3-7,9 151555 or 1N4448
- D8 WZ-061
- D10 VD-1223

AVR UNIT (X43-1420-00)

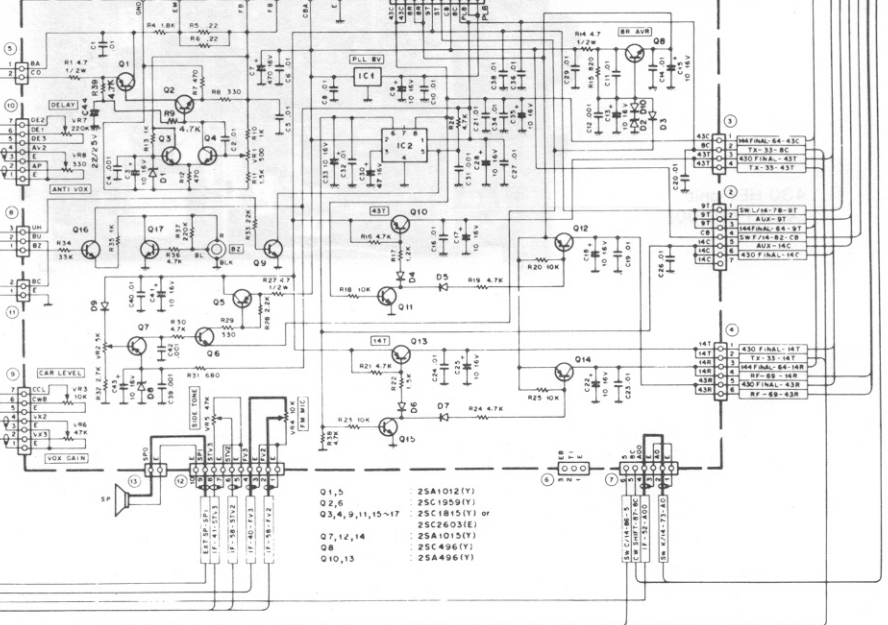

- Q1,5 25A1012(Y)
- Q2,6 25C1959(Y)
- Q3,4,9,11,15-17 25C1815(Y) or 25C2603(E)
- Q7,12,14 25A1015(Y)
- Q8 25C496(Y)
- Q10,13 25A466(Y)

# TOP & BOTTOM INTERNAL VIEWS

AVR unit  
(X43-1420-00)

Control unit  
(X53-1240-61)

PLL unit  
(X50-1770-00)

TX unit  
(X56-1420-00)

144 MHz final unit ass'y  
(X60-1180-51)  
(Under)

430 MHz final unit ass'y  
(X60-1180-00)

IF unit  
(X48-1350-61)

430 HET unit  
(X50-1790-00)

RF unit  
(X44-1470-00)



TOP & BOTTOM INTERNAL VIEWS

Model TS-780

Serial No. \_\_\_\_\_

Date of Purchase \_\_\_\_\_ / \_\_\_\_\_ / \_\_\_\_\_

Dealer \_\_\_\_\_  
\_\_\_\_\_  
\_\_\_\_\_  
\_\_\_\_\_

---

A product of

**TRIO-KENWOOD CORPORATION**

17-5, 2-chome, shibuya, shibuya-ku Tokyo 150, Japan

---

**TRIO-KENWOOD COMMUNICATIONS**

1111 West Walnut Street, Compton California 90220, U.S.A.

**TRIO-KENWOOD COMMUNICATIONS, GmbH**

D-6374 Steinbach TS, Industriestrasse 8A, West Germany

**TRIO-KENWOOD ELECTRONICS, N.V.**

Leuvensesteenweg 504, B-1930 Zaventem, Belgium

**TRIO-KENWOOD (AUSTRALIA) PTY. LTD.**

4E Woodcock Place, Lane Cove N.S.W. 2066, Australia